

P ▲ R ▲ D O X™

2011

PRODUCT CATALOGUE



2011

New Products

MG6250

64-Zone GPRS/GSM
Wireless Console
(see page 30)



TM40

Touch Interface Module
(see page 16 and 33)



NV500

ENVY Series High-
Performance Infrared
Motion Detector
(see page 42)



525DM

Microwave and Infrared
Anti-mask Digital
Motion Detector
(see page 45)



K641LX

LCD Keypad
with Built-in Tranceiver
(see page 17)



iParadox App

Alarm System Control App
(see page 15)



REM101

Emergency/Panic
Remote Control
(see page 39)



K32LX

LCD Keypad
with Built-in Tranceiver
(see page 27)



IPRS-7

IP/GPRS Receiver
Emulator Software
(see page 12)



Updated Products

PCS300

Added
with GSM support
(see page 12)



BabyWare

with Test Mode
(see page 2)











Contents

Imperial Integrated System 1
Communication Modules 11
Digiplex EVO High Security and Access Systems 14
Spectra SP Expandable Security Systems 24
Magellan Wireless Security Systems 30
Motion Detectors 41
Comparison Charts 49
Index 51

Icon Description

Throughout the catalogue, the icons shown below appear alongside product descriptions to which they apply.

	New Product for 2011
	Update to Existing 2010 Product
	Paradox Digital Detection Motion Detectors
	Outdoor Use
	RX/TX Transceiver Technology
	Digital Microwave Detection
	Firmware Upgradable via Multibus
	Pet Immunity
	Supports StayD

The Paradox Company: History and Goals

Personalized Service and Innovative Technology Since 1989

At Paradox, our mission is to provide our customers with personalized service, to manufacture innovative and quality products, and to continually build a strong team – one consisting of our customers, employees, and suppliers. The Paradox team committed to moving forward together, with one unique and common goal.

As a private company, we are not driven by short-term profit or concerned with stock pricing. We are proud to operate in a more traditional manner. Our fuel is our passion towards developing innovative products, all the while fulfilling our customer's wishes and listening to their feedback. Our products are sold only to, and through, our loyal distributors in over 100 countries, most of them exclusive Paradox distributors. This approach ensures that they always receive our undivided attention.

We are not driven by sales, but by supporting our distributors and dealers with the best service and products. We are proud to say that 90% of distributors, and most of our suppliers that started with us in the 1980's, are still our loyal customers today. Every year, we invest heavily into our research and development, therefore, we are always focused on the future. Our goal is to constantly refine our products and adapt to changing technologies and new standards of living. The steadily growing R&D team at Paradox Innovation is continually challenged to create products that are innovative, easy to use, and distinctive – both technologically and aesthetically.

Since 1989, these goals have driven the development of revolutionary products. We started with an impressive line of motion detectors, whose patents are still used in our products today. In 1999, we introduced the Digiplex series of security systems, featuring our encrypted expandable bus system. In 2004, we introduced an extensive range of wireless systems, including the award-winning Magellan all-in-one console. Over the last few years, our focus has shifted progressively towards software development. In 2007, we revamped and shifted many products to new platforms, including the EVO, SP, and MG series. We also introduced advanced communication modules using GPRS, GSM, and IP, as well as in-field firmware-upgradable hardware. In addition, we are also proud of our history, and showed it by re-introducing the Elegance – a beautifully styled motion detector that we first produced 20 years ago.

With personalized service and innovative technology since 1989, the Paradox team works together with our customers and suppliers to reach our goals!



Shmuel HersHKovitz
Founder and owner
Shmuelh@paradox.com

Imperial Integrated System

V32 Imperial Controller

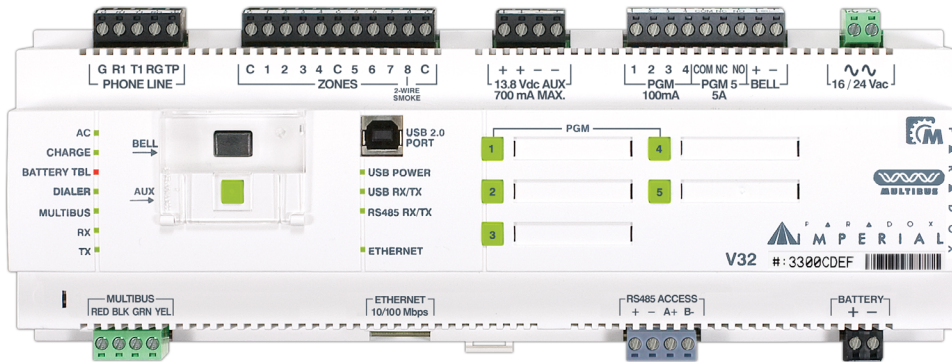

Multibus

- 4-wire encrypted, 13.8 Vdc communication bus at 500 bps
- Multibus automatically switches to RS-485 at 57.6 Kbps for bus module firmware upgrade
- In-field firmware upgrade for panel and multiple bus modules through the Multibus, via local PC or remote IP connection
- Support for up to 511 bus modules

Home Automation

- Imperial home automation is managed by the MAMA engine, using MAMA output modules that control all high or low voltage outputs and MAMA wall switches; together, these modules offer full control of lights (toggle or dimming of incandescent and fluorescent lights), motors, shutters (multiple positions, not just fully open or fully closed), sprinklers (any number of valves activate in sequence or in parallel), air conditioning, heating, and more
- Basic system capacity controls 8 MAMA outputs
- 16 macros per MAMA output module; each output in the system can be controlled by a macro, which can be a system event, timing, sunset/sunrise, sensor input, or energy management feature
- 10,000 home automation events buffered

Access Control

- Standalone operation with independent RS-485 output port
- 64 doors
- 4,000 access cards
- Ultra-fast response time
- 64 access levels
- 256 schedules
- 8,000 access control events buffered
- Simple 4-wire connections between module, controller, and readers

Security

- 32 partitions
- 384 zones (8 on-board zone inputs)
- 250 user codes
- 2,000 security events buffered
- Landline dialer output

Communication

- Built-in TCP/IP communication port (10/100 Mbps) for upload/download via IP, event reporting to a Paradox GPRS/IP Monitoring Receiver (IPR512), or firmware upgrades
- Patented 2-optocoupler dialer circuit – the most reliable dialer in the industry (US Patents 5751803, RE39406)
- 8 simultaneous local/remote BabyWare PC connections

Hardware

- DIN rail enclosure with removable terminals for fast, secure, orderly, and cost-effective installations
- Built-in 1.7A switching power supply
- Transformer sharing enables modules to share central AC (16 to 24 Vac) or DC supply (18 to 30 Vdc) throughout the system
- 1 supervised auxiliary output with local control
- 4 on-board, solid-state, 100 mA PGM outputs (+/- triggering) and 1 NC/NO 5A relay with local control
- 1 supervised bell/siren output
- 66 MHz, 32-bit processor and 66 MHz SDRAM clock
- 32 MB memory on-board for ultra-fast communication with BabyWare PC software, web page, and event storage
- Super Capacitor (no battery) for real-time clock backup for up to 10 days (IP auto-clock adjust when available)

Features Common to All Imperial DIN Modules

- Connects to Multibus: 4-wire encrypted, 13.8 Vdc communication bus at 500 bps (except ACM24D when connected to RS-485 bus)
- Firmware upgradable via Multibus using RS-485 at 57.6 Kbps
- All programming is done using BabyWare PC Software
- DIN rail enclosure with removable terminals for fast, secure, orderly, and cost-effective installations
- Supports 35 mm DIN rail mounting
- Includes labels to identify each zone, door, or output

Software

BabyWare | PC Software

- Upload/download via IP (128 K/bps); via GPRS (38 K/bps) for SP4000
- Connect up to 8 PC users
- Same software for users and installers (user rights)
- Multi-account and multi-user capacity
- User friendly layout and operation
- Easy monitoring and site management tools
- Powerful and fast sort, search, and print capabilities
- Auto-backup for data and powerful *Undo* and *Recycle Bin* features
- Locate module (selected module's LED will flash or be highlighted in software)
-  **Update:** *Test Mode* – tests for zone connectivity and operation



InField | Firmware Upgrade Software

- Upgrade tool for all Paradox firmware (MG6130/MG6160 require UIP256)
- Connect remotely via IP (IP100)
- Connect locally via 307USB or CV4USB
- Built-in links to download the latest firmware
- Automatic adjustment to the hardware's maximum transfer speed
- Simultaneous upgrade of identical Imperial modules



Home Automation Output Modules

DIM1D | 1-Channel Light Dimmer Module

- 1 high-voltage channel for:
 - Phase control dimming
 - Mark X fluorescent dimming
 - 0 to 10V fluorescent dimming
- Output rating: 1000W @ 230V / 500W @ 120V
- Maximum load: 4.4A
- On-board buttons to manually control dim level
- Dim intensity LED display
- 3-LED module status display
- See *Features Common to All Imperial DIN Modules* on page 2

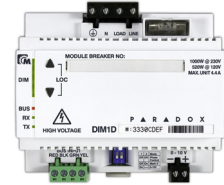

DIM4D | 4-Channel Light Dimmer Module

- 4 high-voltage channels for phase control dimming
- Output rating: 1000W @ 230V / 500W @ 120V (per channel)
- Maximum load: 4.4A per channel (15 total)
- On-board buttons to manually control dim level (per channel)
- Dim intensity LED display (per channel)
- 3-LED module status display
- See *Features Common to All Imperial DIN Modules* on page 2

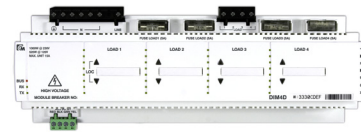

HV8D | 8-Output High-Voltage Relay Module

- 8 high-voltage relay outputs (110/240V, 10A each resistive load)
- Motors up to 1/2 hp (max 8A)
- 2 operating modes: *Relay* and *Shutter*
- *Relay Mode*:
 - 8 high-voltage devices
- *Shutter Mode*:
 - Outputs paired for up/down control of 4 shutters
 - Built-in *Calibration Mode* for open/close timing
 - Emergency stop
 - Global up/down for all connected shutters
- 8 on-board buttons to manually control each output (illuminates to show status)
- 3-LED module status display
- See *Features Common to All Imperial DIN Modules* on page 2

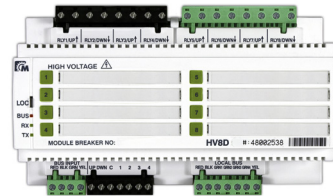

LV8D | 8-Output Low-Voltage Module

- 8 solid-state relay outputs (0-24V AC/DC, 400 mA each)
- Connects to Multibus: 4-wire encrypted, 13.8 Vdc communication bus at 500 bps
- Firmware upgradable via Multibus using RS-485 at 57.6 Kbps
- All programming is done using BabyWare PC Software
- DIN rail enclosure with removable terminals for fast, secure, orderly, and cost-effective installations
- Supports 35 mm DIN rail mounting
- 8 on-board buttons to manually control each output (illuminates to show status)
- 3-LED module status display
- Includes labels to identify outputs



Access Control Modules

ACM24D | 2-Door / 4-Reader Standalone Access Control Module

- Standalone operation via V32's independent 4-wire RS485 Access port (18 AWG, 1000 m/3000 ft.); all programming is transferred to the ACM24D to ensure it continues to operate normally, even if communication with the control panel is lost
- Module processes data locally, which provides ultra-fast response time
- Connections for 2 doors (2 or 4 card readers, 2 REX devices, 2 door contacts, and 2 lock outputs)
- Supports door trap (man trap) applications (coming soon)
- Reader port supports up to 4 R910/R915 4-wire card readers (up to 500 mA)
- 4 inputs for 2 REX devices and 2 door contacts
- 2 lock outputs (6-12 Vdc at 1A each)
- Lock output power jumper (select internal or external power supply)
- 2 external negative triggers: connect a PGM or push-button to unlock door
- 2.85A switching power supply
- Transformer sharing: modules can share a central AC supply (16 to 24 Vac) throughout the system
- Requires AC or DC input voltage (16 to 24 Vac or 16 to 36 Vdc)
- Simple 4-wire connection between readers, module, and panel
- 2 on-board buttons to manually lock or unlock doors (button illuminates to indicate status)
- 5-LED module status display and 4-LED reader status display
- Fully supervised (AC, battery, low battery, and overload)
- Selectable battery charge current (300 or 500 mA)
- Replace an ACM24D and upload a backup of all its programming (cards and events) in under 20 minutes
- See *Features Common to All Imperial DIN Modules* on page 2

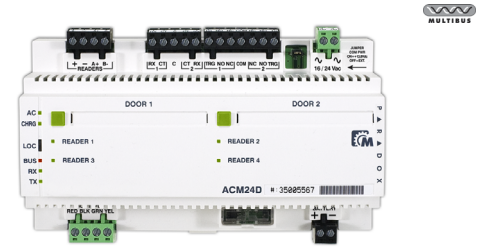

RW485D | Wiegand RS-485 Converter

- Easy connection for up to two 7-wire, Wiegand card readers
- Supports 35 mm DIN rail mounting
- 7-LED module status display
- DIN rail enclosure with removable terminals for fast, secure, orderly, and cost-effective installation
- Bi-directional *Module Locate* feature
- Firmware upgradable via CV4USB converter



R910 | 4-Wire Epoxy-Sealed Indoor/Outdoor Proximity Reader

- Only 4 wires instead of 7 to connect with 4-wire access control modules
- In-field firmware upgradable via CV4USB
- Adjustable red/green LED intensity and buzzer frequency
- Extreme weather-resistant design (epoxy-sealed)
- Tricolor LED display



R915 | 4-Wire Sealed Indoor/Outdoor Proximity Reader and Keypad

- Only 4 wires instead of 7 to connect with 4-wire access control modules
- In-field firmware upgradable via CV4USB
- Adjustable red/green LED intensity and buzzer frequency
- Extreme weather-resistant design (injected rubber gasket and PCB cover)
- Tricolor LED display
- Available in 3 colors: white, silver, or black
- Also available: 910WP and 915WB gang plate covers



Proximity Cards

- **C702:** Clam Shell Card
- **C706:** Two-sided High-Gloss ISO Card
- **C704/S:** Blue Proximity Key Tag
- **RAC1:** Magellan Remote Control with Integrated Access Card
- **RAC2:** Magellan Two-way Remote Control with Integrated Access Card



Power and Hub Modules

PS27D | 4-Output 2.85A Power Supply Module

- 2.85A switching power supply
- Transformer sharing: modules can share a central AC supply (16 to 24 Vac) throughout the system
- Requires AC or DC input voltage (16 to 24 Vac or 16 to 36 Vdc)
- 4 auxiliary outputs providing up to 500 mA each
- Auxiliary outputs can be used in parallel to increase output current
- 7 segment display-to-display, 3-digit voltage, and 3-digit amperage of each output, sum of paralleled outputs, or sum of all outputs
- 4 on-board buttons to manually activate or deactivate each auxiliary output (button illuminates to indicate status)
- 5-LED module status display
- Fully supervised (AC, battery, low battery, and auxiliary limit)
- Selectable battery charge current (350 or 850 mA)
- See *Features Common to All Imperial DIN Modules* on page 2

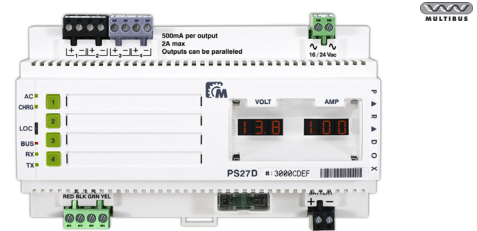

PS100D | AC/DC Switching Power Supply

- Supplies 100W at 16V (6.25A) to drive Imperial modules
- Universal AC input / full range (88-264 Vac)
- Protections: short circuit, overload, over voltage, and over temperature
- Cooling by free air convection
- LED indicator for power On
- No load power consumption < 1W
- Supports 35 mm DIN rail mounting



HUB4D | Hub and Bus Isolator Module

- 1 input port, 4 completely isolated output ports
- Each output port provides communication up to 900 m (3000 ft.), with 18 AWG wire
- Opto-isolated ports provide protection from high-voltage spikes – ideal for exterior lines
- On-board buttons to manually activate or deactivate each hub output
- 4-LED status display per hub output
- 3-LED module status display
- See *Features Common to All Imperial DIN Modules* on page 2

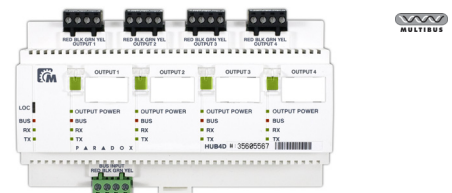

Zone / Input and Wireless Expansion Modules

ZX32D | 32 Zone Expansion Module with 2.85A Power Supply

- Compatible with Imperial and DigiPlex EVO
- 32 addressable zones
- Built-in 1.85A switching power supply
- LED zone status display
- Transformer sharing: modules can share a central AC supply (16 to 24 Vac)
- Requires an AC or DC input voltage (16 to 24 Vac or 16 to 36 Vdc)
- Auxiliary outputs providing up to 1A
- On-board button to manually activate or deactivate each auxiliary output
- 6-LED module status display
- Fully supervised (AC, battery, low battery, and auxiliary limit)
- Selectable battery charge current (350 or 850 mA)
- Set a different input speed for each zone (up to 255 minutes)
- *Test Mode* tests each input
- See *Features Common to All Imperial DIN Modules* on page 2



ZX16D | 16-Zone / Input Expansion Module

- Compatible with Imperial and DigiPlex EVO
- 16 addressable zones
- LED zone status display
- Set a different input speed for each zone (up to 255 minutes) – ideal for temperature monitoring applications
- *Test Mode* tests each input
- See *Features Common to All Imperial DIN Modules* on page 2



ZX8D | 8-Zone / Input Expansion Module

- Compatible with both Imperial and DigiPlex EVO
- 8 addressable zones
- LED zone status display
- Set a different input speed for each zone (up to 255 minutes) – ideal for temperature monitoring applications
- *Test Mode* tests each input
- See *Features Common to All Imperial DIN Modules* on page 2



RTX3 | Wireless Expansion Module

- Compatible with Imperial, DigiPlex EVO, Spectra SP, and Magellan
- 32 wireless zones
- Maximum number of remote controls: 4,000 w/Imperial, 999 w/EVO, and 32 w/SP
- Remote control compatibility:
 - Imperial/EVO/SP: REM1, REM2, REM3, REM15, and REM101
 - Standalone: REM1, REM15, and REM101
- Wireless PGMs (8 w/EVO, 16 w/SP, N/A with Imperial)
- Supports SR150 Wireless Siren (see page 36)
- Works with all Magellan transmitters including 2WPGM
- Supports 2 RPT1 and 8 K32LRF/K37 (Spectra SP only)
- In-field firmware upgradable via CV4USB; via multibus (for Imperial only)
- RF jamming supervision
- Low battery, tamper, and check-in supervision
- Transmitter signal strength display
- 3 PGM outputs and 1 optional output
- Noise level test and indicator



User Controls

The wall switches and sole surface-mount switch plate (WM100) appearing in this section, are available in the following colors:



Dark
Chrome



Charcoal
Metallic



Silver



Light
Chrome



Pearl
Chrome



Gold



Bronze
(frame only)

MSA4H/V | 4-Button Wall Switch

- 4 buttons to control any output (lights, sprinklers, etc.) or group of outputs
- Set in *Toggle* (1 button On/Off) or *Switch Mode* (1 button On / 1 button Off)
- Activation status LED per button
- Single gang box installation
- Backlit button identification
- Connects to Multibus: 4-wire encrypted, 13.8 Vdc communication bus at 500 bps
- Firmware upgradable via Multibus using RS-485 at 57.6 Kbps
- All programming is done using BabyWare PC Software
- 3-LED module status display
- Includes labels to identify each button



MSA8H/V | 8-Button Wall Switch

- 8 buttons to control any output (lights, sprinklers, etc.) or macros (group of outputs)
- Set in *Toggle* (1 button On/Off) or *Switch Mode* (1 button On / 1 button Off)
- Activation status LED per button
- Single gang box installation
- Backlit button identification
- Connects to Multibus: 4-wire encrypted, 13.8 Vdc communication bus at 500 bps
- Firmware upgradable via Multibus using RS-485 at 57.6 Kbps
- All programming is done using BabyWare PC Software
- 3-LED module status display
- Includes labels to identify each button





MVCA2 | 2-Dial Dimmer Wall Switch

- 2 rotary dials, with push On/Off action, dim outputs such as lights, shutters, or macros (group of outputs)
- 8 LEDs per dial to display light intensity or shutter position
- Global button per dial to control an alternate device or macro
- Backlight button to adjust LED light intensity
- Single gang box installation
- Connects to Multibus: 4-wire encrypted, 13.8 Vdc communication bus at 500 bps
- Firmware upgradable via Multibus using RS-485 at 57.6 Kbps
- All programming is done using BabyWare PC Software
- 3-LED module status display

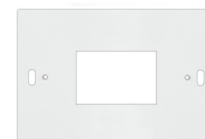

WM100 | Surface-mount Switch Plate

- Alternative to gang box installation
- Fits all wall switches
- Convenient cable routing channel for clean installation



MCB1H/V | 1-Dial / 4-Button Combo Wall Switch

- Combines 4 buttons and 1 rotary dial to control/dim any output (lights, sprinklers, etc.) or macro (group of outputs)
- Set in *Toggle* (1 button On/Off) or *Switch Mode* (1 button On/1 button Off)
- Rotary dial features push-button On/Off control
- Activation status LED per button
- Backlit button identification
- 8-LED display for dial's light intensity or shutter position
- Global button to control an alternate device or macro with rotary dial
- Backlight button to adjust LED light intensity
- Single gang box installation
- Connects to Multibus: 4-wire encrypted, 13.8 Vdc communication bus at 500 bps
- Firmware upgradable via Multibus using RS-485 at 57.6 Kbps
- All programming is done using BabyWare PC Software
- 3-LED module status display
- Includes labels to identify each button



MULTIBUS

MSIN4 | 4-Switch Interface Module

- Connects up to 4 standard switches to the MAMA system
- Supports On/Off and momentary switches
- Color-coded input wires
- LEDs for operation and diagnostic feedback
- Connects directly to the Multibus and is recognized by BabyWare
- Installs inside single gang box, hidden behind wall switch
- Dimensions: 0.41 x 0.29 x 0.09 cm (1.61 x 1.14 x 0.35 in.)

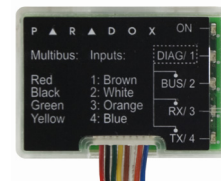

New

MULTIBUS

Keypads

K07C | 32-Partition Grafica Color LCD Keypad

- Upload photos or images using the SD memory card slot
- Supports any 2 colors (16-bit) for background and text
- Supports full color for screensaver display via integrated SD memory card
- Compatible with Imperial and Digiplex EVO
- Firmware upgradable via Multibus using RS-485 at 57.6 Kbps
- Display the status of 32 partitions and 384 zones
- Zone alarm display: zones in alarm are shown until system is disarmed
- 1 built-in indoor temperature sensor
- 1 zone/temperature input; connect a detection device or TEMP07
- Simple text-driven menus, with step-by-step guidance
- Alarm clock and special reminders
- Up to 15 tunes for use with door chiming, entry delay, exit delay, and more
- Independently-set chime zones
- 3 keypad-activated panic alarms
- Supports up to 8 built-in, user-selectable languages in 3 language sets
- Adjustable backlight and volume
- Available in 2 designer colors: silver or champagne
- Dimensions (with door closed): 11.5 x 17 x 3 cm (4.5 x 6.8 x 1.3 in.)
- 6.5 x 6.5 cm (2.6 x 2.6 in.) graphic LCD, with a resolution of 320 x 240 pixels



MULTIBUS

K651 | 32-Character Blue LCD Keypad

- Connects to Multibus: 4-wire encrypted, 13.8 Vdc communication bus at 500 bps
- Firmware upgradable via Multibus using RS-485 at 57.6 Kbps
- All programming is done using BabyWare PC Software
- Display the status of up to 4 partitions and 384 zones
- Zone alarm display: the zones in alarm are shown until the system is disarmed
- 32-character blue LCD with programmable labels
- 1 addressable zone
- Independently-set chime zones
- 14 one-touch action buttons
- 3 keypad-activated panic alarms
- Adjustable backlight, contrast, and scroll speed



Bus Motion Detectors

DGI85 | Outdoor Digital Dual-optic PIR Bus Module (40 kg/90 lb. Pet Immunity)

- Connects to Multibus: 4-wire encrypted, 13.8 Vdc communication bus at 500 bps
- All programming is done using BabyWare PC Software
- Impact and temperature resistant casing
- Operates at -35°C to +50°C (-31°F to +122°F)
- Casing lined with an injected rubber gasket
- UV protected lens
- Dual Optical Filtering System
- Multi-level sensitivity adjustment
- Dual-optics (2 dual-opposed element sensors)
- Provides superior pet immunity (40 kg/90 lb.), using a patented combination of advanced optics and digital processing technologies
- Patented Digital Motion Detection (no analog circuitry)
- Patented Auto Pulse Signal Processing
- Digital Shield algorithm software
- Automatic temperature compensation
- Single or dual-edge processing
- Metal shield maximizes protection from EMI and RFI signals
- 11 x 11 m (35 x 35 ft.) range with 90° viewing angle
- 2 operational modes (bus for Imperial, or conventional relay operation)
- Compatible with the SB85 Heavy-duty Outdoor Swivel Bracket (see page 47)



Dual and Quad-element Motion Detector Bus Modules

DMI50: Dual-element / DMI60: Quad-element

- Connects to Multibus: 4-wire encrypted, 13.8 Vdc communication bus at 500 bps
- All programming is done using BabyWare PC Software
- Patented Digital Motion Detection (no analog circuitry)
- Patented Auto Pulse Signal Processing
- Digital Dual-opposed Detection (DMI60 only)
- Interlock Sensor Geometry (ISG; DMI60 only)
- Digital Shield algorithm software
- Automatic temperature compensation
- Single or dual-edge processing
- Metal shield maximizes protection from EMI and RFI signals
- 12 x 12 m (40 x 40 ft.) range, with 110° viewing angle
- **Compatible with both Imperial and EVO systems**



DMI70 | Digital Dual-optic PIR Bus Module (40 kg/90 lb. Pet Immunity)

Same features as the DMI50, along with the following:

- Dual-optics (2 dual-opposed element sensors)
- Provides superior pet immunity (40 kg/90 lb.), using a patented combination of advanced optics and digital processing technologies
- 11 x 11 m (35 x 35 ft.) range, with 90° viewing angle
- **Compatible with both Imperial and EVO systems**



System Accessories

JCB8 | Junction Box

- Easy connection for up to 8 parallel output connections
- Can be connected in daisy chain configuration
- Easy debugging of each bus tree
- Supports 35 mm DIN rail mounting
- LED confirms bus power (9V or more)

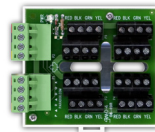

DIN Rails

- 15 mm top-hat rail
- 1 m (39 in.) lengths
- Zinc electroplated with yellow chromate passivation
- Approximate ampacity: 65A



TEMP07 | Temperature Sensor

- Connects to the Grafica's zone/temperature input to measure the exterior temperature
- Maximum distance from the Grafica: 30.5 m (100 ft.)



DB608D | DIN Metal Box with Plexiglass Door

- Specially designed to hold DIN modules
- Multiple modules can be set up on each row
- Bottom row used for easy access to batteries
- Plexiglass door with reversible hinges and locking mechanism
- 60 x 76 x 20 cm (24 x 30.4 x 8 in.)



DIN Rail Cutter

- Cuts TS35, TS35C/R, TS32, and TS15 DIN rails as well as 6 mm (0.25 in.) steel rods
- Punches 8.8 x 5 mm (0.35 x 0.2 in.) oblong holes, in either direction, on the axis of the rail
- Includes 1 m ruler, end stop, and 73 cm (28 in.) high leverage handle

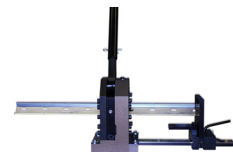

Communication Modules

Monitoring Receiver

IPR512 | GPRS/IP Monitoring Receiver

- High-speed supervision for up to 512 Paradox control panels using IP or GPRS communication; every communication module can report each partition with a unique account number
- End-to-End Supervision: the entire communication line (control panel, receiver, and automation software) is fully supervised and uses Paradox's proprietary encrypted communication
- Up to 32 security profiles can be created per receiver with a programmable Module Polling Time and Receiver Supervision Time (seconds, minutes, or hours)
- All reports are transmitted directly to the receiver from the IP or GPRS modules without having to use intermediary servers or network operation centers
- Redundant Internet Service Provider (ISP): 2 Ethernet ports (WAN1 and WAN2) to receive events through 2 different ISPs
- 2 Serial Ports:
 - COM1 connects to Automation Software (used by monitoring station)
 - COM2 to a serial printer or a PC with an RS232 serial communication software view/print events in plain text format
- Integrated Account Management Web Page: access web page via LAN port to view, edit, and delete GPRS/IP modules, edit security profiles, configure receiver, view receiver troubles, and program special event report codes
- Data backup on external memory card allows fast and easy substitution of receiver units in crash recovery situations; uses external SD, SDHC, or MMC memory cards
- Firmware upgradable in less than 90 seconds
- 128-bit (MD5 and RC4) or 256-bit AES data encryption
- Supports 19 in. rack mounting (1U) or desktop installation
- Automatic date and time synchronization via Network Time Protocol (NTP)
- Standard 110/220 Vac power supply
- Extremely low noise and low power consumption (less than 10W)
- Secure private operating system
- Supports CID and SIA reporting format
- Supported communication protocols for event reporting to the monitoring station's automation software include ADEMCO 685*, SURGARD MLR2-DG*, and RADIONICS 6500*
- For compatibility, please visit our home page at www.paradox.com



*ADEMCO 685, SURGARD MLR2-DG, and RADIONICS 6500 are trademarks of their respective companies

IPRS-7 | IP/GPRS Receiver Emulator Software

- Desktop application that emulates the Paradox GPRS/IP Monitoring Receiver, with unlimited # of accounts
- Converts incoming IP signal from a Paradox communication device to ADEMCO 685, SURGARD MLR2-DG, or RADIONICS 6500 and sends via PC communication
- Received events are converted and stored by the application in CID format, before being dumped on output port in the chosen reporting format
- Selectable input (IP port and GSM/GPRS modem) and output COM port
- Buffer and manage incoming events
- Register, display, and manage IP and GPRS devices
- Support SMS reporting protocol through commercial GSM/GPRS modem
- Monitor GSM/GPRS modem and acknowledge central station on network failure detection
- Allow software personalization through customer logo
- Application auto-starts upon Windows start-up and always runs in background



IP / GPRS / GSM Communication

PCS300 | Universal IP Reporting Module

- **Update:** report events via IP, **GSM**, or GPRS (requires GPRS12 Plug-in Communicator Module; see page 31)
- Report in conjunction with landline or as a backup
- Supports 2 IPR512 GPRS/IP Monitoring Receivers, each with unique reporting sequences
- Module configuration and status via the PCS300 Web Interface
- Support for 2 inputs with report activation capability, including SMS notification
- Firmware upgrades via IP, GSM, or GPRS
- Reports the status of two inputs via SMS (up to 8 cell phone numbers)
- 256-bit (AES) encryption for GSM/GPRS/IP reporting and Web Interface

GPRS12: Plug-in Communicator Module

- Accessory for the PCS300 to support GPRS reporting
- Supports standard GSM provider SIM cards
- Simple installation – connects directly onto PCB



PCS200 | GPRS / GSM Communicator Module

- Report events to the IPR512 GPRS/IP Monitoring Receiver via GPRS
- Fast upload/download via GPRS connection with WinLoad, NEware, or BabyWare, at data rates of up to 38.8 Kbit/s
- Remote firmware upgrade via GPRS, local using 307USB
- Report via text message:
 - Select which event groups will send SMS messages to up to 16 cell phones
 - Each text message contains event description, site name, date, time, and any associated labels – such as area, zone and serial number
 - Event descriptions are pre-defined in the PCS200 module and are available in multiple languages (installer selectable)
- Control panel communication supervision: panel will report to the monitoring station should there be a loss of communication with the control panel
- Simple installation with a 4-wire serial connection
- Optional antenna cable extensions
- 128-bit (MD5) and 256-bit (AES) encryption
- Report events to the IPR512 GPRS/IP Monitoring Receiver via GPRS
- End users can arm/disarm the system by sending an SMS to the PCS200
- Voice reporting; use of the Paradox Plug-in Voice Module (VDMP3) to send pre-recorded voice messages to up to 8 phone numbers to report alarms



EXT | Antenna Extensions

- Accessory for the GPRS12 and GPRS14
- Improve reception by relocating the antenna
- Includes wall mounting bracket
- Cables are available in 6, 12, 24, 48, and 60 ft (1.8, 3.6, 7.3, 14.6, and 18.2 m) lengths



IP100 | Internet Module

- Report events to the Paradox IPR512 GPRS/IP Monitoring Receiver via IP
- Control and monitor a control panel via an IP network (LAN/WAN/Internet)
- Use BabyWare, NEware, or WinLoad to access your system through the Internet
- Receive notification of system alarms via email
- Arm/disarm individual partitions via web browser
- View live status of all zones and partitions (i.e., open/close, arm/disarm, troubles and alarms) via web browser
- Upgrade the firmware of the IP100, using the IP Exploring Tools via the Internet or with the 307USB
- DNS service available for dynamic IP address
- Supports SMTP and ESMTP email services (TLS/SSL not supported)
- Very low bandwidth consumption
- Data sent and received using 128-bit (MD5 and RC4) and 256-bit (AES) data encryption
- Two-way dynamic authentication
- Available in multiple languages
- For compatibility, please visit our home page at www.paradox.com



Voice Communication

VDMP3 | Plug-in Voice Module

- Record a 15-second site ID to identify the installation site (requires EVO V2.10 to program)
- Using pre-recorded voice messages, dial up to 8 telephone numbers with EVO – or up to 5 with Magellan and Spectra – to report a burglar, panic, or fire alarm
- Arm/disarm the system and receive status reports remotely via telephone
- Control PGMs and toggle utility keys remotely via telephone
- Voice-guided menu
- Connects directly onto the control panel or PCS200 module (see page 12)
- In-field upgradable
- Available in multiple languages
- For compatibility, please visit our home page at www.paradox.com

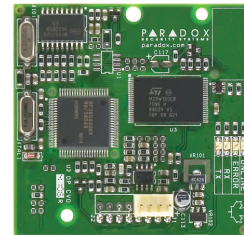

VD710 | ParaVox Voice Dialer

- Local and remote telephone programming
- Provides any control panel with remote voice and pager messaging
- 4 zone inputs and 2 PGM outputs
- 4 telephone and 4 pager numbers
- 1 installer and 4 user PINs
- Voice message length: 4 messages of 15 seconds each or 2 of 30 seconds
- In-field firmware upgradable via 307USB and WinLoad
- Available in multiple languages
- For compatibility, please visit our home page at www.paradox.com



Digiplex EVO High Security and Access Systems

Control Panels

EVO192 | Digiplex EVO 192-Zone Control Panel

-  **Update:** EVO48 is now integrated into the EVO192
- 8 on-board zones (16 w/zone doubling), expandable to 192
- Built-in access control features
- Supports reporting (PCS series), IP (IP100), and voice modules (VDMP3); see page 11
- In-field firmware upgradable via 307USB
- Compatible with NEware V4.0 or higher
- *Automatic Daylight Savings Time* feature
- Supports EOL and ATZ options per zone input and tamper options per zone
- 4 on-board solid-state PGMs, negative or positive triggering / 1 on-board 5A relay output
- PGM1 can be used as a 2-wire smoke input
- Supports up to 254 expansion bus modules
- 999 user codes and up to 999 remote controls, with 1 RTX3
- 8 partitions and 2,048 events buffered
- Built-in real-time clock backup battery
- 1.7A switching power supply
- 1 supervised bell output, auxiliary output, and telephone line
- Patented 2-optocoupler dialer circuit – the most reliable dialer in the industry
- Push-button software reset (reset to default values and restart)
- Push-button to activate or deactivate the auxiliary output
- Fits in a 28 x 28 x 7.6 cm (11 x 11 x 3 in.) metal box

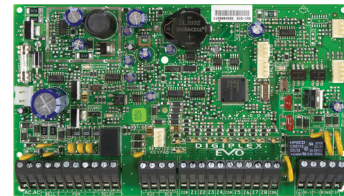

Software

WinLoad | Installer Upload/Download Software

- Connect to WinLoad via GPRS at rates of up to 48 Kbit/s, with a PCS series module (see page 12)
- Supports TCP/IP connections through the IP100 (see page 13)
- User-friendly programming/monitoring of EVO, Spectra SP, and Magellan series
- Remote uploading and downloading via most standard modems, at 300 baud
- On-site (local) uploading and downloading at 57.6K baud (Magellan console), 38.4K baud (EVO), or 9.6K baud (Spectra SP, MG5000, and MG5050), using a 307USB Direct Connect Interface (60 m/200 ft.) or a CV4USB RS-485/RS-232 Converter Kit (300 m/1000 ft.)
- In-field upgrading feature that allows WinLoad to upgrade firmware of certain control panels/modules via a 307USB interface or a CV4USB converter
- Multiple users, groups, and databases
- Network-compatible database
- Advanced printing of reports and zone/user programming
- Supports several languages simultaneously (available in English, Spanish, Chinese, Czech, French, Hebrew, Hungarian, Italian, Polish, Portuguese, Russian, Serbo-Croatian, Slovak, Swedish, and Turkish)

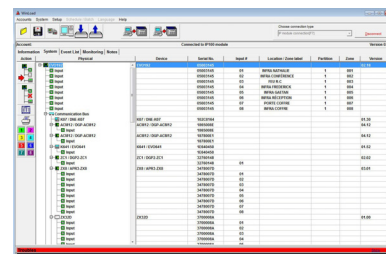

NEware | End-user Management Software

- Supports TCP/IP connections through the IP100 (see page 13)
- Program access codes and settings of users in an EVO192 system
- Live system monitoring (view system and zone status and troubles) without interrupting central station communication or system operation
- Draw and download/upload up to 32 floor plans for Grafica (see page 8)
- Download floor plans, tunes, graphics, and screen savers into Grafica
- Arm/disarm, bypass zones, and control PGMs
- Search, sort, and filter saved system events; generate and print customized reports
- On-site uploading and downloading at 38.4K baud (EVO), using a 307USB (60 m/200 ft.) or CV4USB (300 m/1000 ft.)
- Supports several languages simultaneously
- 3 editions available: Demo; Security; Security and Access Control

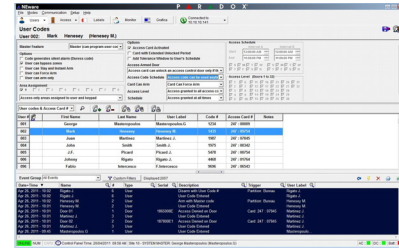

iParadox | Alarm System Control App (Full and Lite Versions)

Full version

- Access your Paradox security system from an Apple device, via Wi-Fi or 3G
- Compatible with iPhone, iPod Touch, and iPad 3G
- Displays live system status, alarm memory, and system troubles
- Arm and disarm your system
- Controls up to 16 PGMs, customizable PGM labels
- PGM activation/deactivation (shows the last PGM action performed from iParadox, not current PGM state)
- Connects with static or dynamic IP (ParadoxMyHome)
- **Compatibility with EVO available Q4 2011**
- Compatible with Spectra SP, MG5000, and MG5050 (requires IP100, version 5.03 or higher),
- Both Lite and Full versions available for download from the App Store

Lite version

- Free preview version of the iParadox app
- Compatible with iPhone, iPod Touch, and iPad 3G
- Connects to a live system and displays its status (open zones, partition status)
- Displays list of PGMs and their labels, and allows editing of visible labels
- Same compatibility as Full version

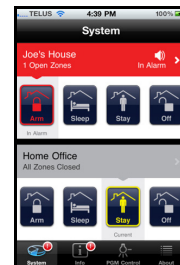

<p>InField Firmware Upgrade Software</p>		<ul style="list-style-type: none"> • Upgrade tool for all Paradox firmware • See page 2 for full description
---	---	--

Keypads

Features Common to All Digiplex Keypads

- Zone alarm display: the zones in alarm are shown until the system is disarmed
- Connects to 4-wire combus
- Assign to 1 or more partitions, 1 addressable zone
- 1 PGM output (except for the TM40, TM4, and K07C)
- Independently-set chime zones
- 14 one-touch action buttons (except for the TM40, TM4, and K07C)
- 3 keypad-activated panic alarms

<p>K07C 32-Partition Grafica Color LCD Keypad</p>		<p>See page 8 for full description</p>
--	---	--

TM40 | Touch Interface Module

- Thin, sleek design
- Intuitive, icon-based interface via touchscreen, with quick menu-driven prompts
- 4.3-inch (10.9 cm) brilliant and vivid widescreen color display
- Compatible with EVO (V2.16 or higher), MG5000/MG5050, SP5500/SP6000/SP7000 (version 4.72 or higher), and SP4000/SP65 (version 4.90 or higher)
- Optional: supports up to 32 floor plans (EVO), or 8 floor plans (MG/SP)
- Optional: supports Annunciator mode (available Q4 2011)
- Customizable labels: zones, areas, users, and PGM outputs
- Controls up to 8 PGM outputs
- Supports WinLoad, not NEware
- External micro SD card slot for firmware upgrades and uploading photos etc.
- Built-in indoor temperature sensor
- 1 zone/temperature input to connect a detection device or exterior temperature sensor (TEMP07)
- Available in multiple languages
- Clean screen mode: locks screen for easy cleaning
- Display: 5.4 x 9.5 cm (2.1 x 2.7 in.) with a resolution of 480 x 272 pixels
- Surface-mount installation only; dimensions: 12.4 x 8.1 x 1.6 cm (4.9 x 3.2 x 0.7 in.)
- Available in 3 finishes: brushed aluminum, brushed black anodized, and brushed white anodized



Home screen for EVO shown on
White Anodized TM40



Annunciator mode shown on
Silver Anodized TM40



Floor Plan screen shown on
Black Anodized TM40

K656 | Touch Sense LCD Keypad

- Touch sense keypad interface
- Connects to Multibus: 4-wire encrypted, 13.8 Vdc communication bus
- Firmware upgradable via Multibus using RS-485 at 57.6 Kbps
- Displays the status of up to 4 partitions and 384 zones
- Zone alarm display: the zones in alarm are shown until the system is disarmed
- 3 keypad-activated panic alarms
- Adjustable backlight, contrast, and scroll speed
- Dimensions: 15 x 8.5 x 2 cm (5.9 x 3.3 x 0.8 in.)



K641 | 32-Character Blue LCD Keypad

- In-field firmware upgradable via CV4USB
- Simplified end-user remote control programming
- 32-character blue LCD with programmable labels (via memory key, WinLoad, NEware, and module broadcast feature)
- See Paradox.com for all available languages
- Adjustable backlight, contrast, and scroll speed
- Display time using the 12 or 24 hr. format
- See *Features Common to All Digiplex Keypads*

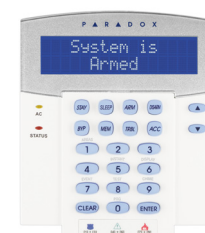

K641LX | 32-Character Blue LCD Keypad with Built-in Transceiver

Same features as the K641, along with the following:

- Built-in transceiver (433 or 868 MHz)
- Wireless range in a typical residential environment: 40 m (130 ft.)



K641R | 32-Character Blue LCD Keypad with Integrated Card Reader

Same features as the K641, along with the following:

- Built-in card reader; simply present access card directly to the keypad
- Grant access via card and/or access code
- Arm and disarm with card
- Door contact and request for exit inputs
- Doorlock output
- Programmable automatic unlocking schedule
- *Door Left Open* and *Door Forced Open* alarms



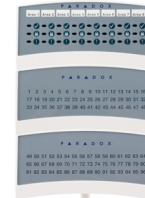

ANC1 | Annunciator Module

- Zone alarm display: the zones in an alarm state will flash until they are disarmed
- LED display shows status of either partitions 1-8, zones 1-48, or zones 49-96
- 3-in-1 product (comes with 3 different display labels)
- Mount as a standalone unit, or over any LCD or LED keypad
- Stack up to 3 annunciators
- Assign to 1 or more partitions



Motion Detector Modules

DMI50 Dual-element Motion Detector Bus Module		See page 9 for full description
DMI60 Quad-element Motion Detector Bus Module		See page 9 for full description
DMI70 Dual-optic PIR Bus Module (Pet Immunity)		See page 10 for full description

Features Common to All Digiplx Motion Detector Modules

- Patented Digital Motion Detection (no analog circuitry)*
- Patented Auto Pulse Signal Processing
- Digital Shield algorithm software
- Automatic temperature compensation
- Single or dual-edge processing
- Connect to the Digiplx EVO 4-wire bus directly
- Metal shield maximizes protection from EMI and RFI signals*

*Except DG467

DG85 | Outdoor Dual-optic High-performance PIR Module

- Special weatherproof design
- Available with 1 of 3 lenses (see page 48 for more details): Pet Array, Horizontal Curtain Beam, or Vertical Curtain Beam lens
- Impact and temperature resistant casing, with UV protected lens
- Operates at -35°C to +50°C (-31°F to +122°F)
- Casing lined with an injected rubber gasket
- Dual-optical Filtering System and Digital Dual-opposed Detection
- Multi-level sensitivity adjustment
- 2 operational modes (addressable for EVO or conventional relay)
- Compatible with the Heavy-duty Outdoor Swivel Bracket (SB85; see page 47)
- Extremely reliable and false-alarm free
- Dual-optics (2 dual-opposed element sensors)
- Provides superior pet immunity using a patented combination of advanced optics and digital processing technologies
- Immune to pets weighing up to 40 kg (90 lb.)
- 11 x 11 m (35 x 35 ft.), with 90° viewing angle
- See *Features Common to All Digiplex Motion Detector Modules*

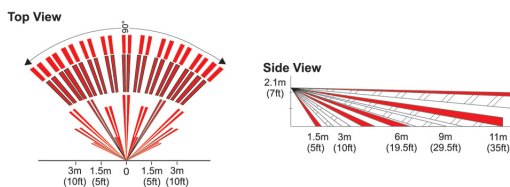

DG467 | 360° Ceiling-mount Motion Detector Module

- Digital Motion Detection
- Dual-element sensor
- 7 x 6 m (24 x 20 ft.) at 2.4 m (8 ft.); 11 x 6 m (35 x 20 ft.) at 3.7 m (12 ft.)
- 360° viewing angle
- Solid-state relay and anti-tamper switch
- 2 operational modes (addressable for the EVO series or conventional relay operation)
- See *Features Common to All Digiplex Motion Detector Modules* on page 17

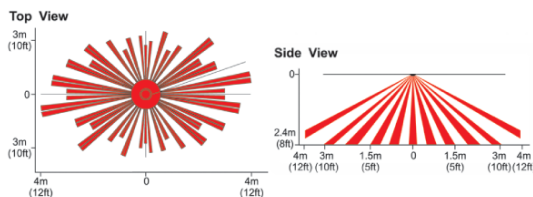

DG457 | Digital Glassbreak Bus Detector



- 2 operational modes (addressable for EVO series or conventional relay operation)
- *Remote Test Mode* when used with TestTrek V2
- Full audio and infrasonic spectrum analysis
- 7 frequency digital filters, digital amplifier gain, and frequency fluctuation assessment
- Impact and shock wave analysis
- High-immunity to RFI and EMI signals
- Sensitivity adjustment: covers up to 9 m (30 ft.) when set to high and up to 4.5 m (15 ft.) when set to low
- TestTrek (459 V2.0) used for testing available separately (see page 47)
- Anti-tamper switch

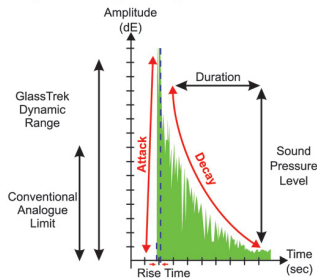

Signal Envelope Analysis



Hardwired Zone Expansion and Door Contact Modules

ZX32D 2-Amp Bus Power Supply		See page 6 for full description
ZX16D 16-Zone / Input Expansion Module		See page 6 for full description
ZX8D 8-Zone / Input Expansion Module		See page 6 for full description

ZC1 | Door Contact Module

- 1 addressable zone
- Small size: 7.4 x 2.0 x 3.5 cm (2.9 x 0.8 x 1.2 in.)



ZX1 | 1-Zone Expansion Module

- 1 addressable zone (2 with ATZ zone doubling feature)
- Set a different input speed for each zone (up to 255 min.) – ideal for temperature monitoring applications



ZX4 | 4-Zone Expansion Module

- 4 addressable zones (8 with ATZ zone doubling feature)
- Set a different input speed for each zone (up to 255 min.) – ideal for temperature monitoring applications
- Use zone input as an anti-tamper switch input



ZX8 | 8-Zone Expansion Module

- Compatible with EVO, Spectra SP, MG5000, and MG5050
- 8 addressable zones (16 with ATZ zone doubling feature)
- Set a different input speed for each zone (up to 255 min.) – ideal for temperature monitoring applications
- 1 PGM output
- Use zone input as an anti-tamper switch input



Wireless Expansion Module

RTX3 Wireless Expansion Module		See page 6 for full description
---	---	---------------------------------

Listen-in Modules

LSN4 | Listen-in Module

- Audio alarm verification (listen-in or two-way communication)
- *Before and after* alarm audio recording and playback
- Message broadcasting (play system status messages through substations)
- Customize or record broadcasted messages
- Remote telephone access (listen-in/two-way, arm/disarm, and system status)
- Communicate or listen to a specific substation
- Toggle between high and low gain on speakers and microphones
- Remotely activate or deactivate the siren
- In-field firmware upgradable via 307USB
- Connect to a music source to play background music through substations
- Supports 4 primary SUB1 substations (fully functional)
- Supports 8 secondary SUB1 substations (used as additional speakers)

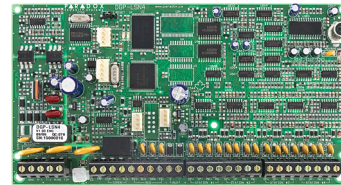

SUB1 | Listen-in Substation

- Unique substation design
- 16-bit sound quality; built-in 7.6 cm (3.0 in.), 3W, 8W speaker
- Built-in high-sensitivity microphone
- Page button (communicate with monitoring station or other substations)
- Panic button (send panic signal to monitoring station)
- Mute button (mute broadcasted messages and background music)
- Volume control knob
- Simple CAT-5 cable connection to a LSN4 Listen-in Module



Access Control Modules

R910 4-Wire Epoxy-sealed Indoor/Outdoor Proximity Reader		See page 4 for full description
R915 4-Wire Sealed Indoor/Outdoor Proximity Reader and Keypad		See page 4 for full description

R870-A | Indoor Proximity Reader

- Indoor installation only
- For single gang box use
- Screw terminals
- 2 status LEDs (red and green) and beeper
- Supports 26-bit Wiegand output format
- Dimensions: 11 x 7.3 x 2 cm (2.8 x 4.5 x 0.8 in.)
- Operating temperature: +10°C to +65°C (+50°F to +149°F)

**R890-BL | Indoor/Outdoor Extended Range Proximity Reader**

- Extreme weather-resistant design (epoxy sealed)
- Up to 61 cm (24 in.) read range with C702 access card
- Automatic read-range calibration
- Supports the 26-bit Wiegand output format
- Tricolor LED display
- Elegant face light

**Proximity Cards**

- **C702:** Clamshell Card
- **C706:** Two-sided, High-gloss ISO Card
- **C704/S:** Blue Proximity Key Tag
- **RAC1:** Magellan Remote Control with Integrated Access Card
- **RAC2:** Magellan Two-way Remote Control with Integrated Access Card

**ACM12 | 4-Wire Access Control Module**

- With the R915, access granted via card and/or panel's user access code
- With the R915, arm with card and pin
- Connections for 1 door (card reader, REX, door contact, and lock output)
- When using R910 or R915, requires only 4 wires between reader and ACM12
- Infield firmware upgradable via CV4USB
- Automatic unlocking schedule
- *Door Left Open* and *Door Forced Open* options
- Door unlock and extended delay timers
- Unlock door manually with button or PGM event
- *Unlock Door on Fire Alarm* option
- *Safe Mode* option (during a communication loss, the access control door connected to the module can grant access to up to 4 specified cards or any valid cards)
- Built-in, supervised, 1.5A switching power supply
- Push-button to activate or deactivate the auxiliary output
- Supports 4-wire and 26-bit Wiegand card readers
- Fits in a 20 x 25.5 x 7.6 cm (8 x 10 x 3 in.) metal box

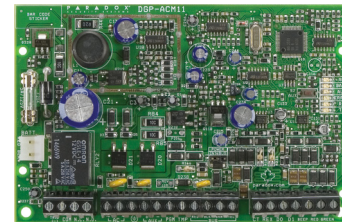
**Power and Hub Modules****PS17 | Power Supply Module**

- 1.7A switching power supply
- Fully supervised (AC, battery, low battery, and auxiliary limit)
- Selectable battery charge current (350 or 850 mA)
- 1 PGM output
- Includes 20 x 25.5 x 7.6 cm (8 x 10 x 3 in.) metal box



HUB2 | 2-Port Hub and Bus Isolator

- Divides the communication bus into multiple, completely isolated outputs
- 1 input port, 2 isolated output ports
- Each output port provides communication at a distance of up to 900 m (3000 ft.)
- Compatible with EVO, Spectra SP, MG5000, and MG5050

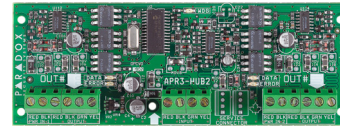

HUB4D | 4-Port Hub and Bus Isolator Module

- Divides the bus into 4 completely isolated outputs
- 1 input port, 4 isolated output ports
- Each output port provides communication at a distance of up to 900 m (3000 ft.)
- Opto-isolated ports provide protection from high-voltage spikes – ideal for exterior lines
- In-field firmware upgradable
- DIN rail enclosure with removable terminals
- Supports 35 mm DIN rail or wall mounting, with retractable mounting clips
- On-board buttons to manually activate or deactivate each hub output
- 4-LED status display per hub output
- 3-LED module status display
- Includes labels to identify each output

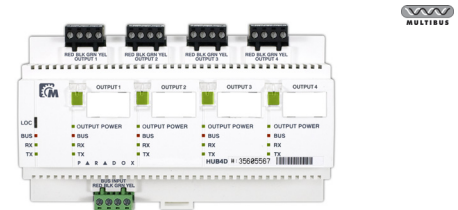

Special Modules

PGM4 | 4-Output Expansion Module

- Compatible with Digiplex EVO, Spectra SP, MG5000, and MG5050
- In-field firmware upgradable via a CV4USB or 307USB and the InField Firmware Upgrade Software
- 4 programmable, 5A relay outputs
- Deactivates PGM after event or timer
- Pulse PGM output for fire alarms

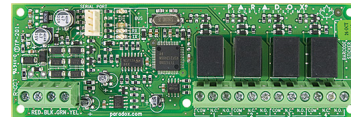

PRT3 | Integration Module

- In-field firmware upgradable via a CV4USB and the InField Firmware Upgrade Software
- Supports ASCII/C-BUS protocols
- 16 virtual inputs to trigger an action in the EVO control panel, based on an event received from the peripheral system, using ASCII or C-BUS protocol
- 30 virtual PGMs to trigger an action in the peripheral system, based on an event received from the EVO control panel, using ASCII or C-BUS protocol
- USB port for PC connections
- Provides an interface between an EVO control panel and a third-party peripheral system
- Automatically/manually prints reports of zone/system events via printer or PC
- Parallel and serial port for printer connections
- Assign to 1 or more partitions
- 2,048 event buffer
- Available in multiple languages

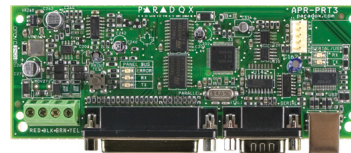

System Accessories

PMC5 | USB Memory Key

- Used to download or upload system programming to or from a PC, with WinLoad or BabyWare
- Lock-switch to prevent accidental loss of data
- LED status indicator
- Download or upload control panel/console programming within seconds
- Connects directly to memory connector on the control panel/console
- No need for a telephone line, PC, or any other peripheral device



307USB | Direct Connect Interface

- Includes 3 LED status indicators (PC, Panel, and RX/TX)
- Incorporates a USB port and a serial port (DB-9)
- Enables control panel to communicate with a PC at a maximum distance of 60 m (200 ft.)
- Connects between panel's serial port connector to a PC's serial port (DB-9) or USB port
- 57.6K baud communication (Magellan console), 38.4K baud communication (EVO), or 9.6K baud communication (Spectra SP, MG5000, and MG5050)



CV4USB | RS-485/RS-232 Converter Kit

- Incorporates a USB port and a serial port (DB-9)
- Enables control panel to communicate with a PC at a distance of up to 300 m (1000 ft.)
- Connects from the control panel's serial port connector to PC's serial port (DB-9) or USB port
- 38.4K or 57.6K baud communication (EVO)



TEMP07 | Temperature Sensor

- Connects to Grafica/TM4/TM40's zone/temperature input to measure the exterior temperature
- Maximum distance: 30.5 m (100 ft.)





Spectra SP Expandable Security Systems

Control Panels

Feature Comparison between Spectra SP Control Panels

Feature	SP4000	SP65	SP5500	SP6000	SP7000
StayD	✓	✓	✓	✓	✓
Maximum Zones	32	32*	32*	32*	32*
On-board Zones	4 (8 w/ATZ)	9 (18 w/ATZ)	5 (10 w/ATZ)	8 (16 w/ATZ)	16 (32 w/ATZ)
Expansion Zones (ZX8)	24 (3 x ZX8)	24 (3 x ZX8)	24 (3 x ZX8)	24 (3 x ZX8)	16 (2 x ZX8)
Keypad Zones	15	15	15	15	15
Partitions	2†	2†	2†	2†	2†
User Codes	32	32	32	32	32
PGMs	12 (1 on-board)	16* (3 on-board)	16* (2 on-board)	16* (2+2** on-board)	16* (4 on-board)
PGM +/- Trigger	-	✓ (via BabyWare)	-	✓	✓
Alarm Relay	-	-	-	1**	1
Events Buffered	256	256	256	256	256
Remote Controls	32‡	32‡	32	32	32
Wireless Keypads (K32RF and K37)	-	-	8	8	8
Wireless Repeater (RPT1; see page 40)	-	✓	2	2	2
Wireless Siren (SR150; see page 36)	-	✓	4	4	4
Wireless Expansion Module (RTX3; see page 6)	✓	✓	✓	✓	✓
Wireless Receiver (RX1; see page 28)	✓	✓	✓	✓	✓
2-Wire Smoke Detector Input	-	-	-	✓	✓
Landline Dialer	✓	-	✓	✓	✓
GPRS/GSM Communication (PCS series; see page 12)	✓	✓	✓	✓	✓
Internet TCP/IP Communication (IP100; see page 13)	✓	✓	✓	✓	✓
Plug-in Voice Module (VDMP3; see page 13)	✓	✓ (via PCS200)	✓	✓	✓
In-field Firmware Upgradable	✓	✓	✓	✓	✓
BabyWare	✓	✓	-	-	-

* Any of which can be wireless

** Optional

† Only 1 partition with K636 keypad

‡ RX1 required

Spectra SP Control Panels

SP4000: 4 to 32-Zone Control Panel

-  **Update:** supports LCD keypads K32LCD and K32LX
- Supports StayD
- 4-wire expansion bus (connect up to 15 keypads)
- 4 zone inputs or 8 with zone doubling; expandable to 32 zones
- 1 on-board PGM
- Supports up to 16 PGMs
- 2 partitions (1 partition when used with K636 keypad)
- 32 user codes
- Supports GPRS and GSM Module (PCS series), IP Module (IP100), and Voice Module (VDMP3); see on page 11
- 1.1A switching power supply
- In-field firmware upgradable via 307USB
- Menu-driven programming for the Installer, Master, and Maintenance codes
- Phone #: 3 for monitoring station, 5 for personal dialing, and 1 for pager reporting
- Patented 2-optocoupler dialer circuit – the most reliable dialer in the industry
- *Automatic Daylight Savings Time* feature
- Push-button software reset (reset to default values and restart)
- Direct connect at 9.6K baud with BabyWare
- 256 events buffered
- Supports REM3, one-way communication only (requires RTX3, V1.31 or higher)
- Supports RX1 Wireless Receiver, as well as RTX3 Wireless Expansion Module
- Fits in 20 x 25.5 x 7.6 cm (8 x 10 x 3 in.) and 28 x 28 x 7.6 cm (11 x 11 x 3 in.) metal boxes

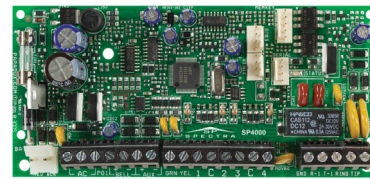

SP4000

STAY D

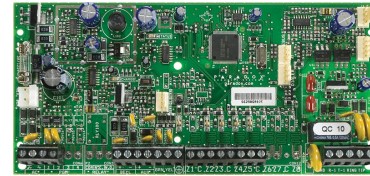

SP5500

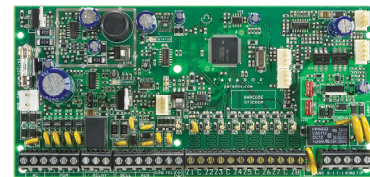

SP6000

SP5500: 5 to 32-Zone Control Panel

Same features as the SP4000, with the following differences:

- 5 zone inputs or 10 with zone doubling; expandable to 32 zones
- Supports REM3, two-way communication (requires RTX3, V1.31 or higher)
- Direct connect at 9.6K baud with WinLoad
- Supports RX1 Wireless Receiver and RTX3 Wireless Expansion Module

SP6000: 8 to 32-Zone Control Panel

Same features as the SP4000, with the following differences:

- 8 zone inputs or 16 with zone doubling; expandable to 32 zones
- Supports REM3, two-way communication (requires RTX3, V1.31 or higher)
- 2 (+ 2 optional) on-board PGM outputs, positive or negative triggering
- 1 alarm relay (optional)
- 1.5A switching power supply
- Supports RX1 Wireless Receiver and RTX3 Wireless Expansion Module

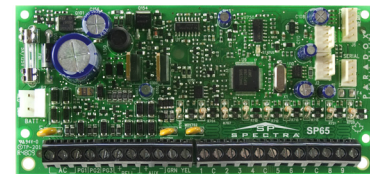

SP65



SP65: 9 to 32-Zone Control Panel

 **Update:** supports LCD keypads K32LCD and K32LX

Same features as the SP4000, with the following differences:

- 9 on-board zones (18 with ATZ); expandable to 32 zones
- Supports REM3, two-way communication (requires RTX3, V1.31 or higher)
- 3 PGM outputs
- No landline dialer (IP and/or GPRS only)

SP7000: 16 to 32-Zone Control Panel



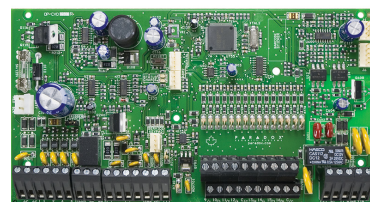

Same features as the SP4000, with the following differences:

- 16 zone inputs or 32 with zone doubling; expandable to 32 zones
- Supports REM3, two-way communication (requires RTX3, V1.31 or higher)
- 4 on-board PGM outputs, positive or negative triggering
- 1 alarm relay (optional)
- 1.5A switching power supply
- Supports RX1 Wireless Receiver and RTX3 Wireless Expansion Module



SP7000

Software

<p>iParadox Alarm System Control App</p>		<ul style="list-style-type: none"> • Compatible with Spectra SP control panels • See page 15 for full description
<p>BabyWare PC Software</p>		<ul style="list-style-type: none"> • For SP series: compatible with SP4000 and SP65 • See page 2 for full description
<p>WinLoad Installer Upload/Download Software</p>		<ul style="list-style-type: none"> • For SP series: compatible with SP5500, SP6000, and SP7000 • See page 14 for full description
<p>InField Firmware Upgrade Software</p>		<ul style="list-style-type: none"> • Upgrade tool for all Paradox firmware • See page 2 for full description

Hardwired Keypads

TM40 | Touch Interface Module

- Thin, sleek design
- Intuitive, icon-based interface via touchscreen, with quick menu-driven prompts
- 4.3-inch (10.9 cm) brilliant and vivid widescreen color display
- Compatible with EVO (V2.16 or higher), MG5000/MG5050, SP5500/SP6000/SP7000 (version 4.72 or higher), and SP4000/SP65 (version 4.90 or higher)
- Optional: supports up to 32 floor plans (EVO), or 8 floor plans (MG/SP)
- Optional: supports Annunciator mode (available Q4 2011)
- Customizable labels: zones, areas, users, and PGM outputs
- Controls up to 8 PGM outputs
- Supports WinLoad, not NEware
- External micro SD card slot for firmware upgrades and uploading photos etc.
- Built-in indoor temperature sensor
- 1 zone/temperature input to connect a detection device or exterior temperature sensor (TEMP07)
- Available in multiple languages
- Clean screen mode: locks screen for easy cleaning
- Display: 5.4 x 9.5 cm (2.1 x 2.7 in.) with a resolution of 480 x 272 pixels
- Surface-mount installation only; dimensions: 12.4 x 8.1 x 1.6 cm (4.9 x 3.2 x 0.7 in.)
- Available in 3 finishes: brushed aluminum, brushed black anodized, and brushed white anodized



Home screen for MG/SP shown on White Anodized TM40



Annunciator mode shown on Silver Anodized TM40



Floor Plan screen shown on Black Anodized TM40

Features Common to All Hardwired Keypads

- Supports StayD
- 1 keypad zone input
- 8 one-touch action buttons
- Independently-set chime zones
- 3 keypad-activated panic alarms
- Connects to 4-wire expansion bus
- Compatible with Spectra SP, MG5000*, and MG5050*

* The K32LX is not compatible with MG5000 and MG5050

K32LCD | 32-Character Hardwired LCD Keypad

- 32-character, blue LCD with programmable labels
- Real-time zone alarm display (until disarmed)
- Menu-driven programming for easy system setup (installer and end-user)
- StayD status LED
- In-field firmware upgradable via 307USB
- Adjustable backlight, contrast, and scroll speed
- 2-partition keypad
- See *Features Common to All Hardwired Keypads* on page 27



STAY D

K32LX | 32-Character Hardwired LCD Keypad with Built-in Transceiver

Same features as the K32LCD, along with the following:

- Built-in transceiver (433 or 868 MHz)
- Wireless range in a typical residential environment: 40 m (130 ft.) with SP4000/SP5500/SP6000/SP7000
- 1 K32LX keypad per system only
- Supports K32RF and K37 keypads
- Not compatible with MG5000 and MG5050
- See *Features Common to All Hardwired Keypads* on page 27



New

STAY D

TRANSCIVER TECHNOLOGY

K35 | 32-Zone Hardwired Fixed LCD Keypad

- Fixed message display that guides you in the operation of the system
- Displays the status of 32 zones in 2 partitions
- StayD status icon
- In-field firmware upgradable via 307USB
- Displays Arm, Sleep, Stay, and Disarmed status for each partition
- Displays troubles, bypassed zones, and alarm memory
- Adjustable backlight
- 2-partition keypad
- See *Features Common to All Hardwired Keypads* on page 27



STAY D

K32 | 32-Zone Hardwired LED Keypad

- 32-zone LED display
- StayD status icon
- In-field firmware upgradable via 307USB
- Separate Arm, Sleep, Stay, and Off LEDs per partition
- Adjustable backlight
- 2-partition keypad
- See *Features Common to All Hardwired Keypads* on page 27



STAY D

K636 | 10-Zone Hardwired LED Keypad

- Single partition keypad
- 10-zone LED display
- StayD status LED
- Patented Key Light display (button illuminates to indicate an open zone)
- Arm, Sleep, Stay and Off keys illuminate to indicate partition status
- Adjustable backlight
- See *Features Common to All Hardwired Keypads* on page 27



K10V and K10H Hardwired LED Keypads



K10V: 10-Zone Hardwired LED Keypad (Vertical)

K10H: 10-Zone Hardwired LED Keypad (Horizontal)

- 10-zone LED display
- StayD status LED
- Separate Arm, Sleep, Stay, and Off LEDs per partition
- Patented Key Light display (button lights up to indicate an open zone)
- Adjustable backlight
- 2-partition keypad
- See *Features Common to All Hardwired Keypads* on page 27



Zone and PGM Expansion Modules

RTX3 Wireless Expansion Module		See page 6 or full description
ZX8 8-Zone Expansion Module		See page 20 for full description
PGM4 4-Output Expansion Module		See page 22 for full description

RX1 | Wireless Receiver

- Compatible with Spectra SP control panels (V4.54 and higher)
- 32 wireless zones
- Up to a maximum of 32 remote controls
- Compatible with remotes REM101, REM1, RAC1, and REM15
- Compatible with transmitters DCT10, DCTXP2, DCT2, PMD1P, PMD75, PMD85, and SD738
- In-field firmware upgradable via the InField Firmware Upgrade Software
- RF jamming supervision
- Low battery, tamper, and check-in supervision
- Transmitter signal strength display
- 2 PGM outputs correspond to buttons 1 and 2 on REM1, RAC1, and REM15 (also programmable through the panel)



ZX8SP | 8-Zone Expansion Module

- Compatible with the Spectra SP series, MG5000, and MG5050
- Add up to 8 additional zones
- 1 PGM output
- Use zone input as an anti-tamper switch input



System Accessories

PMC5 | USB Memory Key

- Used to download or upload system programming to or from a PC, with WinLoad or BabyWare
- Lock-switch to prevent accidental loss of data
- LED status indicator
- Download or upload control panel/console programming within seconds
- Connects directly to memory connector on the control panel/console
- No need for a phone line, PC, or other peripheral device



HUB2 | 2-Port Hub and Bus Isolator

- Divides the communication bus into multiple, completely isolated outputs (if one output fails, the others will continue to function)
- 1 input port, 2 completely isolated output ports
- Each output port provides communication up to 900 m (3000 ft.)
- Compatible with EVO, Spectra SP, MG5000, and MG5050



307USB | Direct Connect Interface

- Includes 3 LED status indicators (PC, Panel, and RX/TX)
- Incorporates a USB port and a serial port (DB-9)
- Enables control panel to communicate with a PC at a maximum distance of 60 m (200 ft.)
- Connects between panel's serial port connector to a PC's serial port (DB-9) or USB port
- 57.6K baud communication (Magellan console), 38.4K baud communication (EVO), or 9.6K baud communication (Spectra SP, MG5000, and MG5050)



Magellan Wireless Security Systems

MG6250 64-Zone GPRS/GSM Wireless Console  



- Communicates via quad-band GPRS/GSM module with 2 SIM cards (GPRS14)
- 2 partitions and up to 64 wireless zones
- Simultaneous Five-channel Reporting (GPRS, GSM, SMS, Voice, and traditional landline)
- Built-in transceiver (433 or 868 MHz)
- Speakerphone via GSM or landline
- Built-in voice and utility reporting (up to 10 telephone numbers)
- Two-way voice communication (via GSM or landline)
- 16 users and 16 remote controls
- 8 wireless PGMs (2 I/Os can be hardwired)
- 256 events buffered
- Supports 4 wireless sirens (SR150)
- Supports 4 wireless keypads (K32RF/K37); displays first 32 zones only
- Supports 4 wireless repeaters (RPT1)
- Supports 16 two-way remotes (REM2/REM3)
- Built-in 90 dB siren
- Remote firmware upgrade via GPRS
- Full voice-assisted remote system access via GSM
- High-quality sound for voice tags and menu guidance
- Family message center (up to 30 sec. with time stamp)
- Clock with alarm

GPRS14 | Plug-in Communicator Module

- Accessory for the MG6250, used to support GPRS/GSM/SMS reporting
- Supports 2 standard GSM provider SIM cards, for provider redundancy
- Simple installation – connects directly onto PCB



New

PA7 | 7.5 Vdc Power Adapter Plug

- Compatible with MG6250
- Provides 7.5 Vdc at 1A max
- Includes 1 of 5 different power outlets: ACPEU (Europe), ACPAUS (Australia), ACPCH (China), ACPUK (United Kingdom), and ACPUL (North America)
- Wire length: 1.83 m (6 ft.)



Control Panels

Feature Comparison between MG5000 and MG5050

Security Features	MG5000	MG5050
StayD	✓	✓
Built-in Transceiver	✓	✓
Maximum Zones (any of which can be wireless)	32	32
On-Board Hardwired Zones	2 (4 with ATZ)	5 (10 with ATZ)
Expansion Zones (ZX8)	24	24
Keypad Zones	15	15
Partitions	2	2
Users	32	32
Remote Controls	32	32
PGMs (any of which can be wireless)	16 (2 on-board)	16 (4 on-board)
Events Buffered	256	256
Wireless Keypads (K32RF and K37)	8	8
Wireless Repeaters	2	2
Expansion Bus	✓	✓
GPRS/GSM Communication (PCS series, see page 12)	✓	✓
Internet TCP/IP Communication (IP100, see page 13)	✓	✓
Voice and Utility Reporting (VDMP3, see page 13)	✓	✓
Wireless Siren (SR150, see page 36)	✓	✓
Personal Dialing	✓	✓
Pager Reporting	✓	✓
In-field Firmware Upgradable	✓	✓

Magellan MG5000 and MG5050 Control Panels

MG5000: Magellan 2 to 32-Zone Wireless Transceiver Control Panel

- Supports StayD
- Built-in transceiver (433 or 868 MHz)
- 32 zones (any of which can be wireless) and 2 partitions
- 32 users and 32 remote controls (1 per user)
- 4-wire communication bus (connect up to 15 keypads)
- 2 on-board hardwired zone inputs (4 with ATZ)
- Supports REM3, 8 K32RFs/K37s, 4 SR150s (see page 36), and 2 RPT1s (see page 40)
- Supports reporting (PCS series), IP (IP100), and voice modules (VDMP3)
- Supports 16 PGMs (any of which can be wireless) and 2 on-board PGMs
- In-field firmware upgradable via 307USB
- Menu-driven programming for the Installer, Master, and Maintenance codes
- Phone #s: 3 monitoring, 5 for personal dialing, and 1 for pager
- Patented 2-optocoupler dialer circuit – the most reliable dialer in the industry
- Push-button power reset
- RF Jamming Supervision
- 9.6K baud communication with WinLoad
- 256 events buffered
- Fits in a 20 x 25.5 x 7.6 cm (8 x 10 x 3 in.) metal box

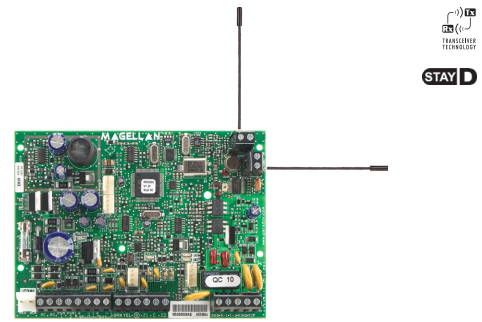

MG5000

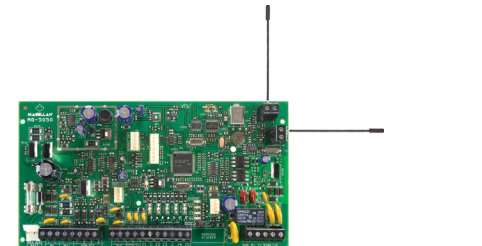





MG5050

MG5050: Magellan 5 to 32-Zone Wireless Transceiver Control Panel

Same features as the MG5000, along with the following:





- 5 on-board hardwired zone inputs (10 with ATZ)
- 4 on-board PGM outputs, positive or negative triggering (PGM4 only)
- Fits in a 8 x 28 x 7.6 cm (11 x 11 x 3 in.) metal box

Software

iParadox Alarm System Control App		<ul style="list-style-type: none"> • Compatible with Magellan control panels • See page 15 for full description
BabyWare PC Software		<ul style="list-style-type: none"> • Compatible with MG6250 • See page 2 for full description
WinLoad Installer Upload/Download Software		<p>See page 14 for full description</p>
InField Firmware Upgrade Software		<ul style="list-style-type: none"> • Upgrade tool for all Paradox firmware • See page 2 for full description

Hardwired Keypads

K32LCD 32-Character Hardwired LCD Keypad		<p>See page 27 for full description</p>
K32 32-Zone Hardwired LED Keypad		<p>See page 27 for full description</p>

<p>K35 32-Zone Hardwired Fixed LCD Keypad</p>		<p>See page 27 for full description</p>
<p>K10V 10-Zone Hardwired LED Keypad (Vertical)</p>		<p>See page 28 for full description</p>
<p>K10H 10-Zone Hardwired LED Keypad (Horizontal)</p>		<p>See page 28 for full description</p>
<p>K636 10-Zone Hardwired LED Keypad</p>		<p>See page 28 for full description</p>

TM40 | Touch Interface Module

- Thin, sleek design
- Intuitive, icon-based interface via touchscreen, with quick menu-driven prompts
- 4.3-inch (10.9 cm) brilliant and vivid widescreen color display
- Compatible with EVO (V2.16 or higher), MG5000/MG5050, SP5500/SP6000/SP7000 (version 4.72 or higher), and SP4000/SP65 (version 4.90 or higher)
- Optional: supports up to 32 floor plans (EVO), or 8 floor plans (MG/SP)
- Optional: supports Annunciator mode (available Q4 2011)
- Customizable labels: zones, areas, users, and PGM outputs
- Controls up to 8 PGM outputs
- Supports WinLoad, not NEware
- External micro SD card slot for firmware upgrades and uploading photos etc.
- Built-in indoor temperature sensor
- 1 zone/temperature input to connect a detection device or exterior temperature sensor (TEMP07)
- Available in multiple languages
- Clean screen mode: locks screen for easy cleaning
- Display: 5.4 x 9.5 cm (2.1 x 2.7 in.) with a resolution of 480 x 272 pixels
- Surface-mount installation only; dimensions: 12.4 x 8.1 x 1.6 cm (4.9 x 3.2 x 0.7 in.)
- Available in 3 finishes: brushed aluminum, brushed black anodized, and brushed white anodized



Home screen for MG/SP shown on White Anodized TM40



Annunciator mode shown on Silver Anodized TM40



Floor Plan screen shown on Black Anodized TM40

Wireless Keypads

Features Common to All Magellan Wireless Keypads

- Supports StayD
- View zone and system status in real time
- Built-in transceiver (433 or 868 MHz)
- In-field firmware upgradable via a 307USB and WinLoad
- Fully functional – can be used to program the control panel
- 8 one-touch action buttons
- 3 keypad-activated panic alarms
- 2-partition keypads

K37 | 32-Zone Wireless Fixed LCD Keypad

- View zone and system status in real time
- Fixed message display that guides users in the operation of the system
- Fully self-powered by 2 AA alkaline batteries (included)
- The 6 Vdc power adaptor is not required but can be used as an alternative power source (PA6 not included)
- Goes into *Sleep Mode* after 20 seconds to save battery life, but remains synchronized with the panel to automatically re-activate upon an entry delay or alarm
- Displays the status of 32 zones in 2 partitions
- Displays StayD status
- Displays Arm, Sleep, Stay, and Disarmed status for each partition
- Displays troubles, bypassed zones, and alarm memory
- Adjustable backlight
- Wireless range in a typical residential environment: 40 m (130 ft.)
- Compatible with MG5000, MG5050, and MG6250; also compatible with Spectra SP (except for SP4000) when using an RTX3
- See *Features Common to All Magellan Wireless Keypads*



K32RF | 32-Zone Wireless LED Keypad

- 32-zone LED display
- Separate Arm, Sleep, Stay, and Off LEDs per partition
- Adjustable backlight
- Includes 3.7 Vdc, Li-Ion rechargeable battery
- Requires mandatory 6 Vdc power adaptor (PA6 not included)
- Wireless range in a typical residential environment: 40 m (130 ft.)
- Compatible with MG5000, MG5050, MG6250, and Spectra SP (except for SP4000)
- See *Features Common to All Magellan Wireless Keypads* on page 34

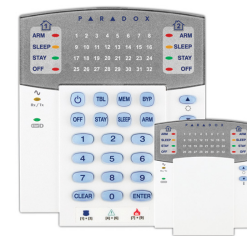

PA6 | 6 Vdc Power Adapter Plug

- Compatible with the K32RF
- Provides 6 Vdc at 350 mA max
- Includes 1 of 5 different power outlets: ACPEU (Europe), ACPAUS (Australia), ACPCH (China), ACPUK (United-Kingdom), and ACPUL (North America)
- Wire length: 1.83 m (6 ft.)



Wireless Motion Detectors

Features Common to All Magellan Wireless Motion Detectors

- Patented Auto Pulse Signal Processing
- Automatic Temperature Compensation
- Alive software (alarm LED continues to display when PIR is in *Energy Save Mode*, without compromising battery life)
- 3-minute *Energy Save Mode* following 2 detections within a 5-minute period
- Available in 433 or 868 MHz
- Low Battery and Detect LED
- Anti-tamper switch

Gsense | Multi-axis Movement Detector

- Multi-axis accelerometer
- Ultra-thin, low-visibility design
- Dual tamper detection for removal or opening of the device
- Adjustable sensitivity:
 - Normal: 1 to 3-second movement
 - Low: 5 to 8-second movement
- Status LED (movement, tamper, enrolling to system)
- Low battery and RF supervision
- *Energy Save Mode* (conserves battery life)
- Attaches to protected item via double-sided tape or screws
- Range: approximately 100 m (328 ft.) in line of sight
- Dimensions: 7.5 x 2.7 x 0.64 cm (3.0 x 1.1 x 0.25 in.)



PMD1P | Analog Single-optic PIR (18 kg/40 lb. Pet Immunity)

- Dual-element sensor
- Immune to animals weighing up to 18 kg (40 lb.)
- 11 x 11 m (35 x 35 ft.) and up to 15 m (50 ft.) for center beams, with 88.5° viewing angle
- Wireless range in a typical residential environment: 35 m (115 ft.) with MG6130/MG6160/MG6250, and 70 m (230 ft.) with MG5000/MG5050 and RTX3
- Power: 3 AA alkaline batteries
- When a higher level of immunity is required, such as when animals are constantly in the detection area, consider using PMD75
- See *Features Common to All Magellan Wireless Motion Detectors*

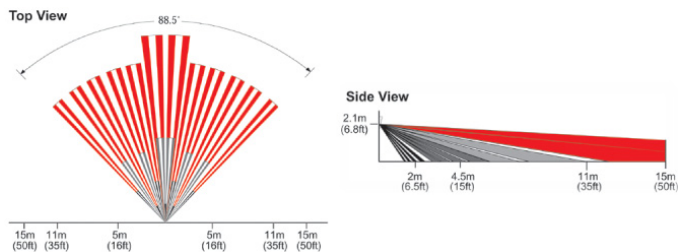

PMD75 | Digital Dual-optic High-performance PIR (40kg/90lb True Pet Immunity)

- Digital Motion Detection
- Dual-optics (2 dual-opposed element sensors)
- Immune to animals weighing up to 40 kg (90 lb.)
- Digital Dual-opposed Detection
- Digital Shield algorithm software, with adjustable sensitivity
- Single or dual-edge processing
- 11 x 11 m (35 x 35 ft.), with 90° viewing angle
- Wireless range in a typical residential environment: 35 m (115 ft.) with MG6130/ MG6160/MG6250, and 70 m (230 ft.) with MG5000/MG5050 and RTX3
- Power: 3 AAA alkaline batteries
- See *Features Common to All Magellan Wireless Motion Detectors* on page 35



Top View

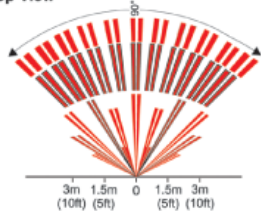

Side View

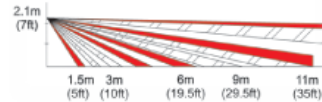

PMD85 | Outdoor Digital Dual-optic High-performance PIR

Same features as PMD75, along with the following:

- Special weatherproof design
- Available with 1 of 3 lenses: Pet Array, Horizontal Curtain Beam, or Vertical Curtain Beam; see *PMD85 / DG85 Lenses* on page 47 for more details
- Impact and temperature resistant casing
- Operates at -35°C to +50°C (-31°F to +122°F)
- Casing lined with an injected rubber gasket
- Dual-optical Filtering System, with UV-protected lens
- Metal shield maximizes protection from EMI and RFI signals
- Multi-level sensitivity adjustment



Wireless Siren

SR150 | Wireless Siren with Built-in Strobe

- Built-in transceiver (433 or 868 MHz)
- 100 db wireless siren, with integrated strobe light
- Weather-resistant design, using a PC/ABS enclosure with UV protection and a silicone-coated PCB (-20°C to 50°C / -4°F to 122°F)
- Battery powered only – no need for AC power
- Fast alarm-response time (4 seconds)
- 8-hour alarm display (strobe flashes every 4 seconds after bell cut-off)
- Siren presence supervised by control panel
- Panel presence supervised by siren (activates siren and strobe for 5 minutes if communication is lost)
- Triple tamper protection: wall, screw, and cover removal
- Assign up to 4 sirens per control panel
- In-field firmware upgradable via 307USB
- *Siren Test Mode*
- 4-LED signal strength and status display
- Strobe lens available in 4 colors: red, blue, amber, or clear
- Fully powered using three 1.5 Vdc, type D alkaline batteries (included); not required, but unit can also be powered using 8-16 Vac / 9-20 Vdc power supply
- Dimensions: 24 x 6 x 18 cm (9.5 x 2.3 x 7 in.)
- Compatible with MG5000, MG5050, MG6130, MG6160, and MG6250; also compatible with SP5500, SP6000, and SP7000, when using an RTX3



Wireless Door Contacts

DCT10 | 2-Zone Long-range Door Contact

- 2-zone capabilities, where each zone is independent and has its own serial number:
 - Zone 1: Use 1 of 2 high-sensitivity reed switches (magnet included); N.O./N.C.
 - Zone 2: universal transmitter input (N.O./N.C.)
- Wireless range in a typical residential environment:
 - 35 m (115 ft.) with MG6130/MG6160/MG6250
 - 70 m (230 ft.) with MG5000/MG5050 and RTX3
- Low battery and signal transmission LED
- Power: 4.5 Vdc (3 AAA alkaline batteries)
- Available in 433 or 868 MHz
- Anti-tamper switch
- Dimensions: 12.4 x 4.5 x 3.3 cm (4.9 x 1.8 x 1.3 in.)



DCTXP2 | 2-Zone Wireless Door Contact

- 2-zone capabilities – each zone is independent and has its own serial number:
 - Zone 1: 1 high-sensitivity reed switch (magnet included)
 - Zone 2: universal transmitter input (N.O./N.C.)
- Wireless range in a typical residential environment:
 - 30 m (100 ft.) with MG6130/MG6160/MG6250
 - 60 m (200 ft.) with MG5000/MG5050 and RTX3
- Low battery and signal transmission LED
- Power: 3.0 Vdc (2 AAA alkaline batteries)
- Available in 433 or 868 MHz
- Anti-tamper switch
- Dimensions: 11.2 x 3.2 x 2.5 cm (4.4 x 1.3 x 1 in.)
- Available in 2 colors: white or brown



DCT2 | Ultra-small Door Contact

- 1 high-sensitivity reed switch (magnet included)
- Wireless range in a typical residential environment:
 - 20 m (65 ft.) with MG6130/MG6160/MG6250
 - 40 m (130 ft.) with MG5000/MG5050 and RTX3
- Power: one 3V lithium battery (DL2450)
- Available in 433 or 868 MHz
- Anti-tamper switch
- Dimensions: 4.4 x 3.0 x 1.9 cm (1.7 x 1.2 x 0.75 in.)



Remote Controls

REM3 | Hand-held Two-way Remote Keypad

- 2 user modes:
 - *Keypad Mode*: requires code entry
 - *Remote Mode*: one-touch arm and disarm
- Supports StayD
- Configure which partitions the REM3 arms and disarms
- Built-in transceiver (433 or 868 MHz)
- Provides visual and auditory feedback of actions performed
- Press the Status button at any time to receive the system status
- Displays Arm, Sleep, Stay, or Off status of partitions 1 and 2
- Diagnostic Display: place REM3 at location of desired transmitter:
 - Partition 1 LEDs display signal strength
 - Partition 2 LEDs display noise floor level
- Use keys to toggle up to 6 PGMs or generate a panic
- Includes label identification slot
- Compact, water-resistant design
- Dimensions: 8 x 3.4 x 1.5 cm (3.1 x 1.3 x 0.6 in.)
- Compatible with EVO, MG5000, MG5050, MG6250, and Spectra SP* (when using RTX3); also compatible with K32LX and K641LX

* Only one-way communication available with SP4000

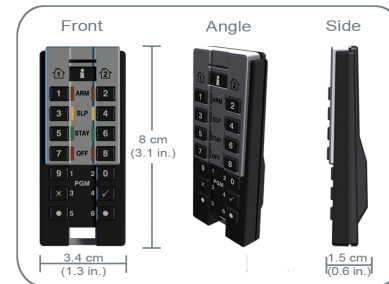

REM2 and RAC2 Remote Controls

REM2: Magellan Two-way Remote Control with Backlit Buttons

- Supports StayD (Version 2.0 or higher)
- Built-in transceiver (433 or 868 MHz)
- Displays system status using visual (LED) and auditory feedback
- Press the Status button at any time to receive the system status
- Perform up to 6 different actions per remote control
- Compact, water-resistant design, with backlight for buttons
- Includes label identification slot
- Wireless range in a typical residential environment:
 - 30 m (100 ft.) with MG6130/MG6160/MG6250
 - 45 m (150 ft.) with MG5000/MG5050, RTX3, K32LX, and K641LX

RAC2: Magellan Two-way Remote Control with Integrated Access Card

Same features as the REM2, along with the following:

- Built-in access card – simply present remote control to a reader
- For compatibility, please visit our home page at www.paradox.com



REM15 | Magellan Remote Control with Backlit Buttons

- Weather resistant
- Slim, ergonomic design, with 4 backlit buttons
- Perform up to 5 different actions
- Wireless range in a typical residential environment:
 - 30 m (100 ft.) with MG6130/MG6160/MG6250 and RX1
 - 45 m (150 ft.) with MG5000/MG5050, K32LX, and K641LX
 - 60 m (200 ft.) with RTX3, MG-RCV3, OMN-RCV3, 1759EX, 1759MG, Available in 433 or 868 MHz
- Easily replaceable battery



REM101 | Emergency/Panic Remote Control

- Weather resistant
- Panic function allows user to instantly send panic signal to monitoring station
- Manually-activated battery test function
- Visual indicator (LED) for arming actions and battery testing
- Includes lanyard attachment to facilitate portability; optional wrist strap, belt clip, and wall-mount also available
- Includes easily-replaceable CR2032 battery, with a battery life of 3 years
- Available in 2 colors: black and white
- Wireless range in a typical residential environment:
 - 30 m (100 ft.) with MG6130/MG6160/MG6250 and RX1
 - 45 m (150 ft.) with MG5000/MG5050, K32LX, and K641LX
 - 60 m (200 ft.) with RTX3
- Available in 433 or 868 MHz



REM1 and RAC1 Remote Controls

REM1: Magellan Remote Control with Backlit Buttons

- Stylish, clear blue plastic, with backlight for buttons
- Perform up to 5 different actions
- Includes label identification slot
- Wireless range in a typical residential environment:
 - 30 m (100 ft.) with MG6130/MG6160/MG6250 and RX1
 - 45 m (150 ft.) with MG5000/MG5050, K32LX, and K641LX
 - 60 m (200 ft.) with RTX3, OMN-RCV3
- Available in 433 or 868 MHz







RAC1: Magellan Remote Control with Integrated Access Card

Same features as the REM1, along with the following:

- Built-in access card – simply present remote control to a reader
- For compatibility, please visit our home page at www.paradox.com

Zone and PGM Expansion Modules

RTX3 Wireless Expansion Module		See page 6 for full description
ZX8 8-Zone Expansion Module		See page 20 for full description
ZX8SP 8-Zone Expansion Module		See page 28 for full description
PGM4 4-Output Expansion Module		See page 22 for full description

System Accessories

RPT1 | Magellan Wireless Repeater Module

- Built-in transceiver (433 or 868 MHz)
- Extends the range of wireless communication
- Supports all Magellan transmitters (including two-way)
- In-field firmware upgradable via a 307USB and WinLoad
- Select the zone, PGM, and/or keypad signals that will be repeated
- Signal strength display
- RF jamming supervision
- Fully supervised by panel or console
- 1 programmable, 5A relay output
- Universal transmitter input (N.O./N.C.)
- Wireless range in a typical residential environment: 75 m (240 ft.) with 433 MHz, or 50 m (160 ft.) with 868 MHz
- Compatible with MG series, SP series with RTX3, Magellan All-in-one Wireless Consoles
- AC input (16 Vac, 20 VA)
- Fits in 20 x 25.5 x 7.6 cm (8 x 10 x 3 in.) and 28 x 28 x 7.6 cm (11 x 11 x 3 in.) metal boxes

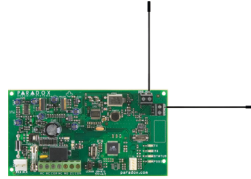

PMCS | USB Memory Key

- Used to download or upload system programming to or from a PC, with WinLoad or BabyWare
- Lock-switch to prevent accidental loss of data
- LED status indicator
- Download or upload control panel/console programming within seconds
- Connects directly to memory connector on the control panel/console
- No need for a phone line, PC, or other peripheral device



2WPGM | Magellan Two-way Wireless PGM

- Built-in transceiver (433 or 868 MHz)
- *Backup Alarm Reporting* option (activates PGM output if communication between the Magellan console and the 2WPGM is lost)
- 1 programmable, 5A relay output
- Deactivates PGM after event or timer
- Requires AC or DC input voltage (6 Vac to 16.5 Vac, or 5 Vdc to 30 Vdc)
- Universal transmitter input (N.O./N.C.)
- Wireless range in a typical residential environment: 35 m (115 ft.) with MG6130/MG6160/MG6250, or 70 m (230 ft.) with MG5000/MG5050 and RTX3
- Anti-tamper switch
- Dimensions: 12.4 x 4.5 x 3.3 cm (4.9 x 1.8 x 1.3 in.)



307USB | Direct Connect Interface

- Includes 3 LED status indicators (PC, Panel, and RX/TX)
- Incorporates a USB port and a serial port (DB-9)
- Enables control panel to communicate with a PC at a maximum distance of 60 m (200 ft.)
- Connects between panel's serial port connector to a PC's serial port (DB-9) or USB port
- 57.6K baud communication (Magellan console), 38.4K baud communication (EVO), or 9.6K baud communication (Spectra SP, MG5000, and MG5050)



SD738 | EVERday Smoke Detector

- High-sensitivity photoelectric smoke sensor
- Built-in siren
- Wireless range in a typical residential environment: 30 m (100 ft.) with MG6130/MG6160/MG6250, or 60 m (200 ft.) with MG5000/MG5050 and RTX3
- Available in 433 or 868 MHz
- Power: 9V battery
- Manufactured and available exclusively through **EVERday** Technology Co. Ltd. (Taiwan)



UIP256 | Universal In-field Programmer

- Upgrade Magellan console and Grafica (V1.21 to 1.4) firmware locally in the field
- Includes proprietary PC software, cables to interconnect a Magellan console and a PC, and two 9V batteries
- The supplied PC software retrieves the latest Magellan update file (firmware) from our website, and then updates the Magellan console



HUB2 | 2-Port Hub and Bus Isolator

- Divides the communication bus into multiple, completely isolated outputs (if one output fails, the others will continue to function)
- 1 input port, 2 completely isolated output ports
- Each output port provides communication up to 900 m (3000 ft.)
- Compatible with EVO, Spectra SP, MG5000, and MG5050



Motion Detectors

Product Comparison for PIR Motion Detectors

Type	Detection	Stability	RFI Rejection	PET Immunity	Overall
Wall-mount Dual/Semi Quad PIRs					
Semi Quad Element PIR	★★★★★☆☆	★☆☆☆☆☆☆	★★★★☆☆☆☆	★★★★☆☆☆☆	★★★★☆☆☆☆
Standard Dual Element PIR	★★★★★☆☆	★★☆☆☆☆☆☆	★★★★☆☆☆☆	★★★★☆☆☆☆	★★★★☆☆☆☆
Paradox Dual Element PIR	★★★★★☆☆	★★★★☆☆☆☆	★★★★☆☆☆☆	★★★★☆☆☆☆	★★★★☆☆☆☆
Ceiling-mount PIRs					
Dual Element	★★★★★☆☆	★★☆☆☆☆☆☆	★★★★☆☆☆☆	★★★★☆☆☆☆	★★★★☆☆☆☆
Semi Quad	★★★★★☆☆	★★☆☆☆☆☆☆	★★★★☆☆☆☆	★★★★☆☆☆☆	★★★★☆☆☆☆
Quad PIRs					
Standard Quad Element PIRs	★★★★★☆☆	★★★★★☆☆	★★★★☆☆☆☆	★★★★☆☆☆☆	★★★★★☆☆
Paradox Quad Element PIRs	★★★★★☆☆	★★★★★☆☆	★★★★★☆☆	★★★★☆☆☆☆	★★★★★☆☆
2x Dual PIRs					
Standard 2x Dual PIRs	★★★★★☆☆	★★★★★☆☆	★★★★☆☆☆☆	★★★★★☆☆	★★★★★☆☆
Paradox 2x Dual PIRs	★★★★★☆☆	★★★★★☆☆	★★★★★☆☆	★★★★★☆☆	★★★★★☆☆

Digital Motion Detectors

Features Common to All Digital Motion Detectors





- Patented Digital Motion Detection*
- Patented Auto Pulse Signal Processing
- Digital Shield algorithm software, with adjustable sensitivity
- Single or dual-edge processing**
- Automatic temperature compensation
- Metal shield maximizes protection from EMI and RFI signals**†
- Solid-state relay
- Anti-tamper switch



* The patent does not apply to the DG467 (see page 18)

** Except DG466 (see page 43)

† Except DG483 and DG467 (see page 43 and page 18, respectively)

DG85 Outdoor Dual-optic High-performance PIR Module (Pet Immunity)		See page 18 for full description	PMD85 Outdoor Dual-optic High-performance PIR		See page 36 for full description
PMD75 Dual-optic High-performance PIR (True Pet Immunity)		See page 36 for full description	DG467 360° Ceiling-mount Motion Detector		See page 18 for full description

ENVY Series: Introducing the all-new NV500



The NV500 is the entry-level motion detector from Paradox's ENVY line of next generation motion detection. Featuring advanced processing technology, optical technology, and easy installation, the ENVY Series represents state of the art technology, with the best value/performance on each of its products.

With precision and equalized detection, superior detector stability, total area coverage, and complete false alarm protection, the NV500 is the most advanced and innovative digital infrared detector in its class.

NV500 | High-Performance Infrared Motion Detector

- Infrared motion detector managed by fully-digital software
- Paradox's Hybrid Cylindrical-Spherical 1.0" lens with 3rd generation 3D Lodif® Fresnel segments- the most advanced lens in the industry (12 x 12 m (40 x 40 ft.), with 90° viewing angle, and 0.5 m (1.6 ft) to max range (no dead zone beam pattern)
- Paradox's equalized detection pattern - ensures equal sensitivity throughout the protected area
- Paradox Super Creep down-looking beam optic option for straight down detection
- Small Pet Immunity up to 16 kg (35 lb)
- Dual/Single Edge Processing selection - the only one in its class
- Paradox patented Dual Digital Auto Pulse Signal Processing (APSP) with two-level selection
- Optional smart wall/ceiling mount bracket
- Miniature, yet easy to install with no PCB removal or adjustment
- CE and EN50131 Grade 2 approved (see PARADOX.com for all approvals)
- Digitally equalized temperature compensation; unit performance specifically tailored to obtain same catch capability at all specified operating temperatures
- Digital Sensitivity trimmer adjustment with five range levels and LED feedback, allows for perfect unit adjustment for all room sizes
- Interchangeable lenses; 90° standard lens, long range and curtain available 1st quarter 2012.
- Best value/performance and most versatile in its class

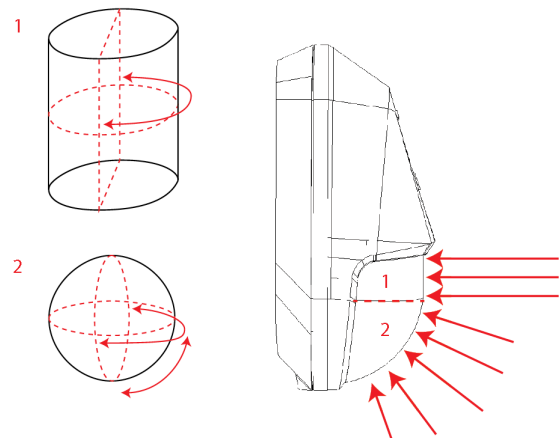
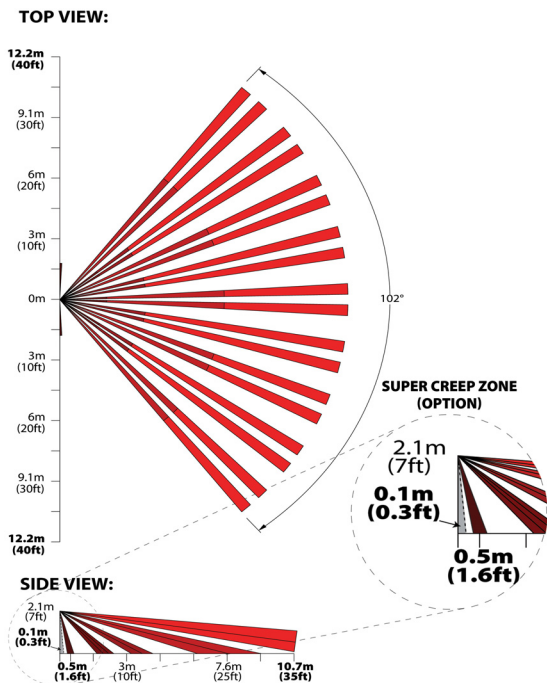

DG483 | Elegance Motion Detector

- Dual-element sensor
- 10 x 10 m (32 x 32 ft.), with 85° viewing angle
- Unique, simple design
- Small size: 8.5 x 5.2 x 3.5 cm (3.3 x 2 x 1.4 in.)
- Includes corner bracket
- Fresnel FLAT Lodif segment lens array: 11 X 11 m (35 x35 ft.), with 85° viewing angle
- See Features Common to All Digital Motion Detectors on page 41

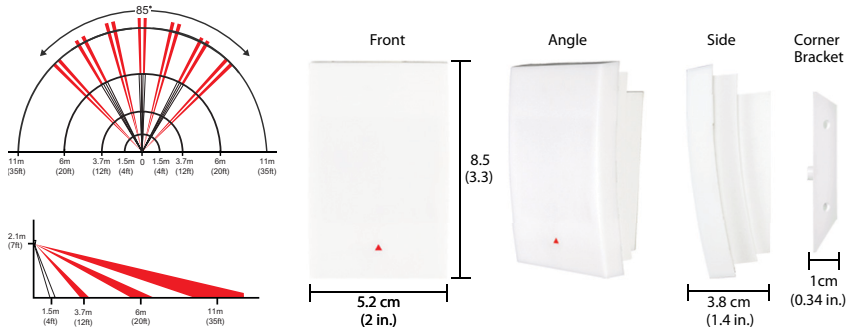

DG466 | Directional Ceiling-mounted Motion Detector

- 2 dual-element sensors (determine if movement is incoming or outgoing)
- 1 incoming and 1 outgoing detection relay output
- Adjustable return delay timer (exit and re-enter without triggering an alarm)
- 0.67 x 4.8 m (2.2 x 16 ft.) and 0.6 x 4.8 m (2 x 16 ft.)

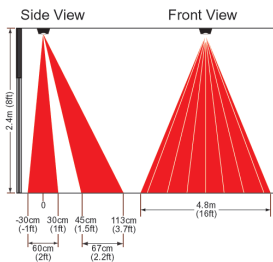

DG55 and DG65 Motion Detectors

DG55: Dual-element Motion Detector

- Dual-element sensor
- 12 x 12 m (40 x 40 ft.), with 110° viewing angle
- See *Features Common to All Digital Motion Detectors* on page 41

DG65: Quad-element Motion Detector

- Digital Dual-opposed Detection
- Interlock Sensor Geometry
- Quad-element sensor
- 12 x 12 m (40 x 40 ft.), with 110° viewing angle
- See *Features Common to All Digital Motion Detectors* on page 41



Top View

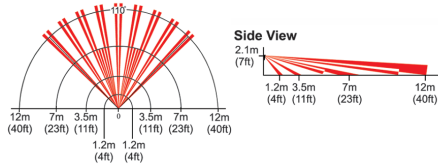

DG75 | Dual-optic High-performance PIR (40 kg/90 lb. True Pet Immunity)

- Extremely reliable and false-alarm free
- Dual-optics (2 dual-opposed element sensors)
- Provides superior pet immunity using a patented combination of advanced optics and digital processing technologies
- Immune to pets weighing up to 40 kg (90 lb.)
- Digital Dual-opposed Detection
- 11 x 11 m (35 x 35 ft.), with 90° viewing angle
- See *Features Common to All Digital Motion Detectors* on page 41



Top View

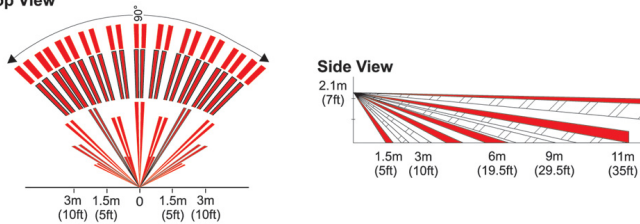

525DM | Microwave and Infrared Anti-mask Digital Motion Detector

- Anti-mask feature: detects movements in close proximity, at a distance of less than 0.75 m (2.5 ft.) within the detector's range
- 2 auto-pulse settings: 1 for typical environment; 1 for high false alarm rejection
- Enhanced and well-balanced sensitivity adjustment
- *Installer Test Mode*: allows testing of microwave and infrared detection separately
- LED feedback displays anti-mask and installer test features
- CE approved
- See *Features Common to All Digital Motion Detectors* on page 41

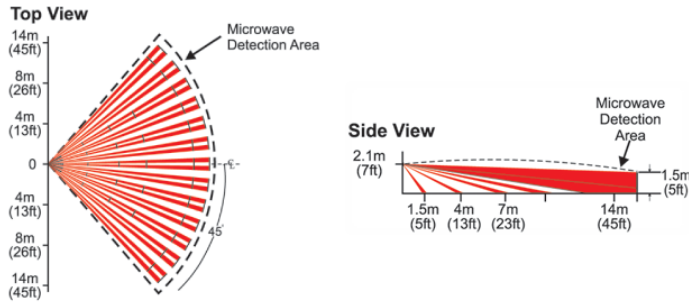

Analog Motion Detectors

Features Common to All Analog Motion Detectors

- Patented Auto Pulse Signal Processing
- Automatic temperature compensation
- Metal shield maximizes protection from EMI and RFI signals
- Dual-element sensor
- Anti-tamper switch

<p>PMD1P Single-optic PIR (18 kg/40 lb. Pet Immunity)</p>		<p>See page 35 for full description</p>
---	--	---

476+ | PIR with High EMI and RFI Rejection

- Extremely high EMI and RFI rejection
- PCB uses only surface-mount components
- Solid-state relay
- 11 x 11 m (35 x 35 ft.), with 110° viewing angle
- See *Features Common to All Analog Motion Detectors*

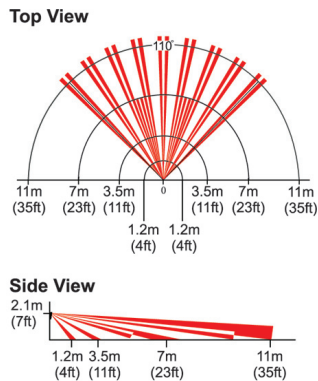

476PET | Single-optic PIR (18 kg/40 lb. Pet Immunity)

- Immune to animals weighing up to 18 kg (40 lb.)
- When a higher level of immunity is required, such as when animals are constantly in the detection area, consider using DG75
- 11 x 11 m (35 x 35 ft.) and up to 15 m (50 ft.) for center beams, with 88.5° viewing angle
- Extremely high EMI and RFI rejection
- PCB uses only surface-mount components
- Solid-state relay
- See *Features Common to All Analog Motion Detectors* on page 45

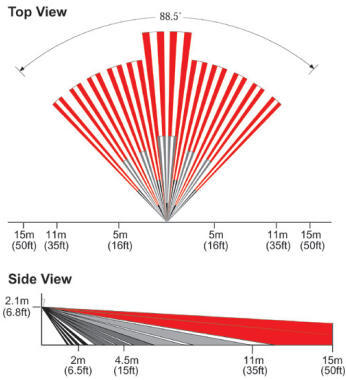

460 | Vertical-view Motion Detector

- Adjustable lens position (0° or 10°)
- Selectable operational voltage (12 or 24 Vdc)
- Adjustable alarm signal duration
- Detects hand-sized objects for card access applications: 2.1 x 1.5 m (7 x 5 ft.)
- Detects body-sized objects for security applications: 6 x 4.5 m (20 x 15 ft.)
- See *Features Common to All Analog Motion Detectors* on page 45

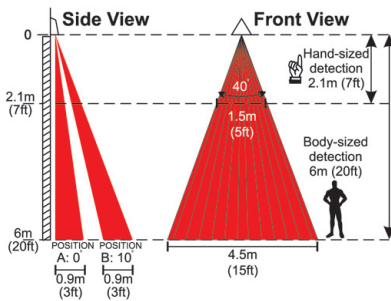

Specialized Detectors

<p>DG457 Digital Glassbreak Bus Detector</p>		<p>See page 19 for full description</p>
<p>457 Digital Glassbreak Detector</p>		<p>Similar to the DG457 (see page 19), however, it only offers the conventional relay operation mode</p>

950 | Safe Protector

- High-sensitivity piezoelectric element
- 5 sensitivity settings
- 2.5 m (8 ft.) protection range
- Anti-tamper switch



Accessories

SB85 | Heavy-duty Outdoor Swivel Bracket

- For use with the PMD85 (see page 36) and DG85 series (see page 18) of outdoor, digital PIRs



- Innovative T-joint allows for movement along 2 axes, for easier maneuverability and better detector positioning
- 3 in 1: ceiling, wall, or corner-mount bracket
- Cap-lock prevents unauthorized repositioning of outdoor detector



SB469 | Swivel-mount Bracket

- 3 in 1: ceiling, wall, or corner-mount bracket
- Ensures optimal coverage



459 | Test Trek

- Toggle *Test Mode* remotely
- Use with DG457 and 457 to test modules



Motion Detector Lenses

The beam patterns shown in this section represent the optional lenses that are available for the Pro+, Digigard 55, Digigard 65, select Digiplex Motion Detector Modules, Digital Vision, and Magellan motion detectors.

PMD85 / DG85 Lenses

Distances shown may vary according to the selected motion detector. Please verify the motion detector's specifications.

Pet Array

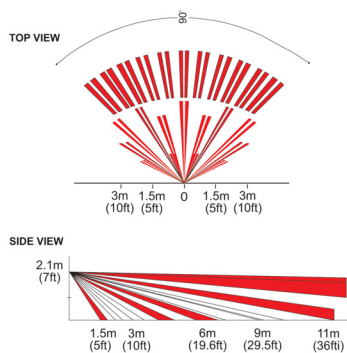

- Patented Animal Immunity (up to 40 kg/90 lbs.)
- 11 x 11 m (35 x 35 ft.), with 90° viewing angle

Horizontal Curtain Beam

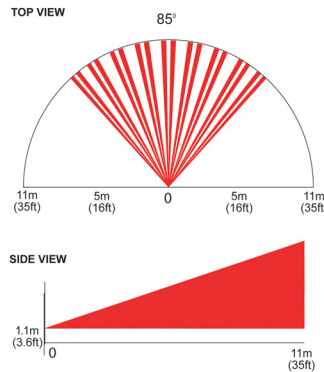

- Allows large-breed dogs and multiple pets to roam freely below the 1.1 m (3.6 ft.) detection level
- 11 x 11 m (35 x 35 ft.), with 90° viewing angle

Vertical Curtain Beam

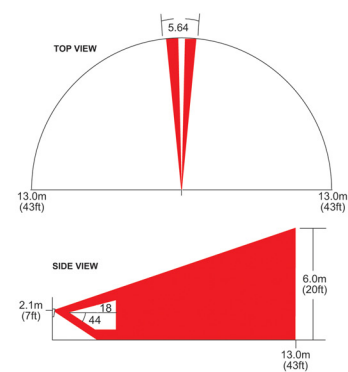

- Protect corridors or vertical surfaces such as walls or balcony doors
- 13 m (43 ft.) x 2 beams, with 5.64° viewing angle

476+, DG55, DG65, and PMD1P Lenses

Distances shown may vary according to the selected motion detector. Please verify the motion detector's specifications.

WIDE ANGLE-2

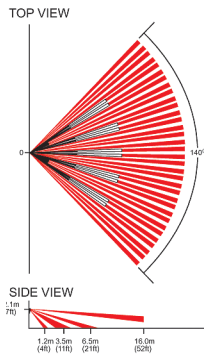

WIDE ANGLE-3

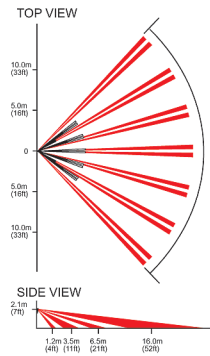

CURTAIN-1

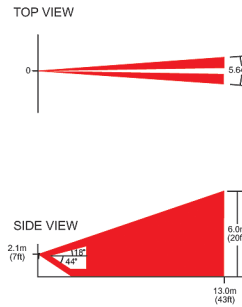

PET ALLEY

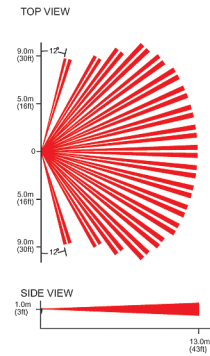

LONG RANGE-1

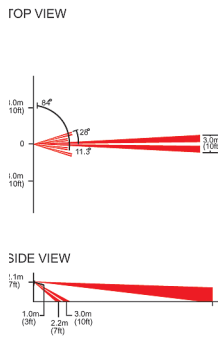

LONG RANGE-2

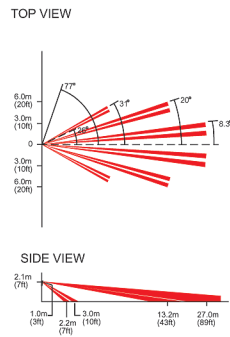

LONG RANGE-3

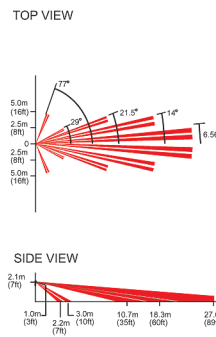

LONG RANGE-4

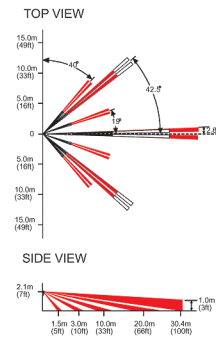

Comparison Charts

Digital Motion Detectors

Features	Motion Detectors									
	DG483	DG55	DG65	DG75	DG85	525DM	DG466	DG467	PMD75	PMD85
Auto Pulse Signal Processing	✓	✓	✓	✓	✓	✓	✓	✓	✓	✓
Auto Temperature Compensation	✓	✓	✓	✓	✓	✓	✓	✓	✓	✓
Auto-mask Feature	-	-	-	-	-	✓	-	-	-	-
Shield Algorithm	✓	✓	✓	✓	✓	✓	✓	✓	✓	✓
Dual-edge Processor	✓	✓	✓	✓	✓	✓	-	✓	✓	✓
Dual-opposed	-	-	✓	✓	✓	-	-	-	✓	✓
Interlock Sensor Geometry	-	-	✓	-	-	-	-	-	-	-
Metal Shield	-	✓	✓	✓	✓	-	-	-	-	✓
Optional Lenses	-	✓	✓	-	✓	✓	-	-	-	✓
Special	-	-	-	-	Outdoor	Microwave	Directional	-	Wireless	Wireless outdoor
Animal Immunity	-	-	-	40 kg / 90 lb.	40 kg / 90 lb.	-	-	-	40 kg / 90 lb.	40 kg / 90 lb.
Sensor	Dual-element	Dual-element	Quad-element	2 dual-elements	2 dual-elements	Dual-element	2 dual-elements	Dual-element	2 dual-elements	2 dual-elements
Coverage (Viewing Angle)	See page 43	See page 44	See page 44	See page 44	See page 18	See page 45	See page 43	See page 18	See page 36	See page 36

Analog Motion Detectors

Features	Motion Detectors			
	476+	476PET	460	PMD1P
Auto Pulse Signal Processing	✓	✓	✓	✓
Auto Temperature Compensation	✓	✓	✓	✓
Shield Algorithm	-	-	-	-
Dual-edge Processor	-	-	-	-
Dual-opposed	-	-	-	-
Interlock Sensor Geometry	-	-	-	-
Metal Shield	✓	✓	✓	-
Optional Lenses	✓	-	-	✓
Special	-	-	Vertical view	Wireless
Animal Immunity	-	18 kg / 40 lb.	-	18 kg / 40 lb.
Sensor	Dual-element	Dual-element	Dual-element	Dual-element
Coverage (Viewing Angle)	See page 45	See page 46	See page 46	See page 35

Control Panels

		Control Panels								
<i>Features</i>		Imperial V32	EVO192	SP4000	SP5500	SP6000	SP65	SP7000	MG5000	MG5050
On-board Zones/ Maximum		8 / 34	8 / 192 (+ 8 virtual)	4 / 32	5 / 32	8 / 32	9 / 32	16 / 32	2 / 32	5 / 32
Partitions (Areas)		32	8	2*	2*	2*	2*	2*	2*	2*
Users		256 (+ 3,744 cards)	999	32	32	32	32	32	32	32
On-board PGMs/ Maximum		5 / 350	5 / 250	1/10	2 / 16	2 / 16	3/10	4 / 16	2 / 16	4 / 16
Expansion Modules		511	254	15	15	15	15	15	15	15
Built-in Access Control (Doors)		64	32	-	-	-	-	-	-	-
Buffered Events		20,000: access; 2,000: security; 10,000: MAMA	2,048	256	256	256	256	256	256	256
Software		BabyWare	WinLoad / NEware	BabyWare	WinLoad	WinLoad	BabyWare	WinLoad	WinLoad	WinLoad
Wireless Expansion		✓	✓	✓	✓	✓	✓	✓	✓	✓
In-field Upgradable		✓	✓	✓	✓	✓	✓	✓	✓	✓

* Only 1 partition with K636

Index

#s

2WPGM	40
307USB	23, 29, 40
457	46
459	47
460	46
476+	45
476PET	46
525DM	45
950	47

A

ACM12	21
ACM24D	4

B

BabyWare	2, 26, 32
----------------	-----------

C

communication modules	11
IP / GPRS / GSM communication	12
IP monitoring receiver	11
voice communication	13
comparison charts	
all-in-one consoles	50
analog motion detectors	49
control panels	50
digital motion detectors	49
CV4USB	23

D

DB608D	10
DCT10	37
DCT2	37
DCTXP2	37
DG457	19, 46
DG466	43
DG467	18, 41
DG483	43
DG55	44
DG65	44

DG75	42, 44
DG85	18, 41
DGI85	9
Digiplex EVO	14
access control module	20
control panels	14
hardwired zone expansion modules	19
keypads	15
listen-in module	20
motion detector modules	17
power and hub module	21
product overview	14
proximity cards	21
software	14
special modules	22
system accessories	23
wireless expansion module	20

DIM1D	3
DIM4D	3
DIN rail cutter	10
DIN rails	10
DMI50	9, 17
DMI60	9, 17
DMI70	10, 17

E

EVO192	14
EXT	13

G

GPRS12	12
GPRS14	31
Gsense	35

H

HUB2	22, 29, 40
HUB4D	5, 22
HV8D	3

I

Imperial	
access control modules	4
bus motion detectors	9
home automation modules	3

keypads	8	MG5050	32
product overview	1	Motion detectors	41
proximity cards.....	5	motion detectors	
software	2	accessories.....	47
system accessories.....	10	analog detectors.....	45, 49
user controls.....	7	digital detectors.....	41, 49
V32 controller.....	1	lenses	47
InField.....	2, 15, 26, 32	specialized detectors	46
IP100	13	MSA4H/V.....	7
iParadox.....	15	MSA8H/V.....	7
IPR512.....	11	MSIN4.....	8
J		N	
JCB8.....	10	NEware.....	15
K		NV500.....	42
K07C.....	8, 15	P	
K10H.....	28, 33	PA6.....	34
K10V.....	28, 33	PA7.....	31
K32.....	27, 32	PCS200.....	12
K32LCD.....	27, 32	PCS300.....	12
K32LX.....	27	PGM4.....	22, 28, 39
K32RF.....	34	PMC5.....	23, 29, 40
K35.....	27, 33	PMD1P.....	35, 45
K37.....	34	PMD75.....	36, 41
K636.....	28, 33	PMD85.....	36, 41
K641.....	16, 17	proximity cards	5
K641LX.....	17	PRT3.....	22
K641R.....	17	PS100D.....	5
K651.....	9	PS17.....	21
K656.....	16	PS27D.....	5
L		R	
LSN4.....	20	R870-A.....	21
LV8D.....	3	R890-BL.....	21
M		R910.....	4, 20
Magellan.....	30	R915.....	4, 20
all-in-one consoles.....	30	RAC1.....	39
control panels.....	31	RAC2.....	38
keypads.....	34	REM1.....	39
overview for consoles.....	30	REM101.....	39
overview for control panels.....	30	REM15.....	38
remote controls.....	38	REM2.....	38
software.....	32	REM3.....	38
system accessories.....	40	RPT1.....	40
wireless door contacts.....	37	RTX3.....	6, 20, 28, 39
wireless motion detectors.....	35	RW485D.....	4
wireless siren.....	36	RX1.....	28
zone and PGM expansion modules.....	39		
MCB1H/V.....	8		
MG5000.....	32		

S

SB469.....	47
SB85.....	47
SD738	40
SP4000.....	25
SP5500.....	25
SP6000.....	25
SP65.....	25
SP7000.....	25
Spectra SP	
control panels	24
hardwired keypads	26
overview	24
software	26
system accessories	29
zone and PGM expansion modules	28
SR150.....	36
SUB1	20

T

TEMP07	10, 23
TM40	16, 26, 33

U

UIP256.....	40
-------------	----

V

V32 controller	1
VD710	13
VDMP3.....	12, 13

W

WinLoad.....	14, 26, 32
WM100.....	7

Z

ZC1.....	19
ZX1.....	19
ZX16D.....	6, 19
ZX32D.....	6, 19
ZX4.....	19
ZX8.....	20, 28, 39
ZX8D	6, 19
ZX8SP.....	28, 39

Patents

One or more of the following US patents may apply: 7046142, 6215399, 6111256, 6104319, 5920259, 5886632, 5721542, 5287111, 5751803, and RE39406 and other pending patents may apply. Canadian and international patents may also apply.

Trademarks

Imperial, BabyWare, Spectra, Spectra SP, WinLoad, Digiplex, Digiplex EVO, NEware, Grafica, Elegance, Digigard, Digital Vision, ProPlus, ProPET, Paradoor, Paradome, GlassTrek, and Magellan are trademarks or registered trademarks of Paradox Ltd. or its affiliates in Canada, the United States and/or other countries. All rights reserved. LODIFF® is a registered trademark of Fresnel Technologies Inc. Windows® is a registered trademark of Microsoft Corporation. ShatterPro™ is a trademark of Interlogix Inc. iPod Touch, iPhone, and iPad 3G are registered trademarks of Apple® Inc. App StoreSM is a service mark of Apple® Inc.

Approvals

For the latest information on product approvals, such as UL and CE, please visit our website at paradox.com.

Specifications

Specifications may change without prior notice. Printed in Canada - 08/2011; CATAEC-11-1B
© 2002-2011 Paradox Ltd.

Paradox Worldwide Offices



Montreal
Manufacturing Center & Paradox Innovation (R&D)



Miami
Distribution Center



Bahamas
International Sales Office



Europe
Paradox Europe (R&D)



MG6250

64-Zone GPRS/GSM All-in-one Wireless Console

The MG6250 takes all-in-one consoles to another level. Featuring Simultaneous Six-channel reporting (IP, GPRS, GSM, SMS, Voice, and traditional landline), this 2-partition, 64-zone wireless console is the complete security solution. Packed with features and an array of consumer conveniences, the MG6250 meets all your security needs. The new generation of consoles is here.

The all-new MG6250.



Look for more new products inside
or visit us at:

PARADOX.COM

Actual design or features described in this catalog may be different to those depicted. Visit paradox.com for the latest updates.